

User Manual

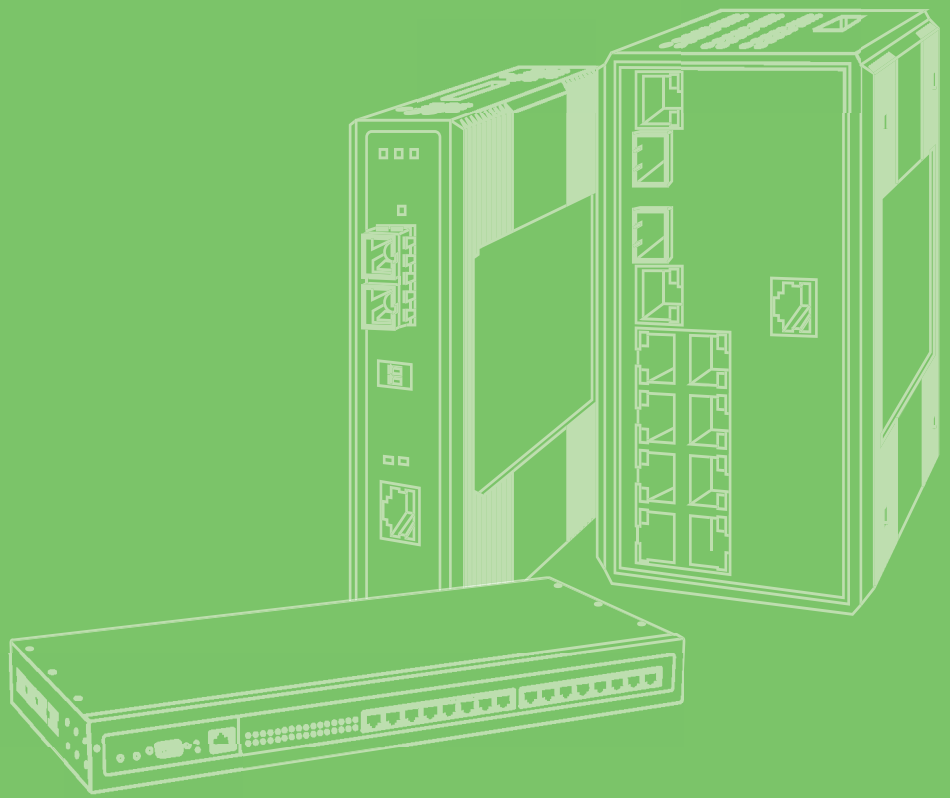

EKI-7428 Series

24GE+4G Combo/24GE PoE+4G
Combo Port L2 Managed Switch

AVANTECH

Enabling an Intelligent Planet

Copyright

The documentation and the software included with this product are copyrighted 2021 by Advantech Co., Ltd. All rights are reserved. Advantech Co., Ltd. reserves the right to make improvements in the products described in this manual at any time without notice. No part of this manual may be reproduced, copied, translated or transmitted in any form or by any means without the prior written permission of Advantech Co., Ltd. Information provided in this manual is intended to be accurate and reliable. However, Advantech Co., Ltd. assumes no responsibility for its use, nor for any infringements of the rights of third parties, which may result from its use.

Acknowledgements

Intel and Pentium are trademarks of Intel Corporation.

Microsoft Windows and MS-DOS are registered trademarks of Microsoft Corp.

All other product names or trademarks are properties of their respective owners.

Product Warranty (5 years)

Advantech warrants to you, the original purchaser, that each of its products will be free from defects in materials and workmanship for five years from the date of purchase.

This warranty does not apply to any products which have been repaired or altered by persons other than repair personnel authorized by Advantech, or which have been subject to misuse, abuse, accident or improper installation. Advantech assumes no liability under the terms of this warranty as a consequence of such events.

Because of Advantech's high quality-control standards and rigorous testing, most of our customers never need to use our repair service. If an Advantech product is defective, it will be repaired or replaced at no charge during the warranty period. For out-of-warranty repairs, you will be billed according to the cost of replacement materials, service time and freight. Please consult your dealer for more details.

If you think you have a defective product, follow these steps:

1. Collect all the information about the problem encountered. (For example, CPU speed, Advantech products used, other hardware and software used, etc.) Note anything abnormal and list any on screen messages you get when the problem occurs.
2. Call your dealer and describe the problem. Please have your manual, product, and any helpful information readily available.
3. If your product is diagnosed as defective, obtain an RMA (return merchandise authorization) number from your dealer. This allows us to process your return more quickly.
4. Carefully pack the defective product, a fully-completed Repair and Replacement Order Card and a photocopy proof of purchase date (such as your sales receipt) in a shippable container. A product returned without proof of the purchase date is not eligible for warranty service.
5. Write the RMA number visibly on the outside of the package and ship it prepaid to your dealer.

Declaration of Conformity

CE

This product has passed the CE test for environmental specifications. Test conditions for passing included the equipment being operated within an industrial enclosure. In order to protect the product from being damaged by ESD (Electrostatic Discharge) and EMI leakage, we strongly recommend the use of CE-compliant industrial enclosure products.

FCC Class A

Note: This equipment has been tested and found to comply with the limits for a Class A digital device, pursuant to part 15 of the FCC Rules. These limits are designed to provide reasonable protection against harmful interference when the equipment is operated in a commercial environment. This equipment generates, uses, and can radiate radio frequency energy and, if not installed and used in accordance with the instruction manual, may cause harmful interference to radio communications. Operation of this equipment in a residential area is likely to cause harmful interference in which case the user will be required to correct the interference at his own expense.

Technical Support and Assistance

1. Visit the Advantech web site at www.advantech.com/support where you can find the latest information about the product.
2. Contact your distributor, sales representative, or Advantech's customer service center for technical support if you need additional assistance. Please have the following information ready before you call:
 - Product name and serial number
 - Description of your peripheral attachments
 - Description of your software (operating system, version, application software, etc.)
 - A complete description of the problem
 - The exact wording of any error messages

Warnings, Cautions and Notes

Warning! Warnings indicate conditions, which if not observed, can cause personal injury!



Caution! Cautions are included to help you avoid damaging hardware or losing data. e.g.



There is a danger of a new battery exploding if it is incorrectly installed. Do not attempt to recharge, force open, or heat the battery. Replace the battery only with the same or equivalent type recommended by the manufacturer. Discard used batteries according to the manufacturer's instructions.

Note! Notes provide optional additional information.



Document Feedback

To assist us in making improvements to this manual, we would welcome comments and constructive criticism. Please send all such - in writing to: support@advantech.com

Packing List

Before setting up the system, check that the items listed below are included and in good condition. If any item does not accord with the table, please contact your dealer immediately.

- 1 x L2 Managed Switch
- 1 x DIN-Rail mounting Bracket and Screws
- 1 x Wall-mounting Bracket

Safety Instructions

1. Read these safety instructions carefully.
2. Keep this User Manual for later reference.
3. Disconnect this equipment from any AC outlet before cleaning. Use a damp cloth. Do not use liquid or spray detergents for cleaning.
4. For plug-in equipment, the power outlet socket must be located near the equipment and must be easily accessible.
5. Keep this equipment away from humidity.
6. Put this equipment on a reliable surface during installation. Dropping it or letting it fall may cause damage.
7. The openings on the enclosure are for air convection. Protect the equipment from overheating. **DO NOT COVER THE OPENINGS.**
8. Make sure the voltage of the power source is correct before connecting the equipment to the power outlet.
9. Position the power cord so that people cannot step on it. Do not place anything over the power cord.
10. All cautions and warnings on the equipment should be noted.
11. If the equipment is not used for a long time, disconnect it from the power source to avoid damage by transient overvoltage.
12. Never pour any liquid into an opening. This may cause fire or electrical shock.
13. Never open the equipment. For safety reasons, the equipment should be opened only by qualified service personnel.
14. If one of the following situations arises, get the equipment checked by service personnel:
 15. The power cord or plug is damaged.
 16. Liquid has penetrated into the equipment.
 17. The equipment has been exposed to moisture.
 18. The equipment does not work well, or you cannot get it to work according to the user's manual.
 19. The equipment has been dropped and damaged.
 20. The equipment has obvious signs of breakage.
21. **DO NOT LEAVE THIS EQUIPMENT IN AN ENVIRONMENT WHERE THE STORAGE TEMPERATURE MAY GO -40°C (-40°F) \sim 85°C (185°F). THIS COULD DAMAGE THE EQUIPMENT. THE EQUIPMENT SHOULD BE IN A CONTROLLED ENVIRONMENT.**
22. **CAUTION: DANGER OF EXPLOSION IF BATTERY IS INCORRECTLY REPLACED. REPLACE ONLY WITH THE SAME OR EQUIVALENT TYPE RECOMMENDED BY THE MANUFACTURER, DISCARD USED BATTERIES ACCORDING TO THE MANUFACTURER'S INSTRUCTIONS.**
23. The sound pressure level at the operator's position according to IEC 704-1:1982 is no more than 70 dB (A).

DISCLAIMER: This set of instructions is given according to IEC 704-1. Advantech disclaims all responsibility for the accuracy of any statements contained herein.

Wichtige Sicherheitshinweise

1. Bitte lesen sie Sich diese Hinweise sorgfältig durch.
2. Heben Sie diese Anleitung für den späteren Gebrauch auf.
3. Vor jedem Reinigen ist das Gerät vom Stromnetz zu trennen. Verwenden Sie Keine Flüssig-oder Aerosolreiniger. Am besten dient ein angefeuchtetes Tuch zur Reinigung.
4. Die NetzanschlusBsteckdose soll nahe dem Gerät angebracht und leicht zugänglich sein.
5. Das Gerät ist vor Feuchtigkeit zu schützen.
6. Bei der Aufstellung des Gerätes ist auf sicheren Stand zu achten. Ein Kippen oder Fallen könnte Verletzungen hervorrufen.
7. Die Belüftungsöffnungen dienen zur Luftzirkulation die das Gerät vor überhitzung schützt. Sorgen Sie dafür, daB diese Öffnungen nicht abgedeckt werden.
8. Beachten Sie beim. AnschluB an das Stromnetz die AnschluBwerte.
9. Verlegen Sie die NetzanschlusBleitung so, daB niemand darüber fallen kann. Es sollte auch nichts auf der Leitung abgestellt werden.
10. Alle Hinweise und Warnungen die sich am Geräten befinden sind zu beachten.
11. Wird das Gerät über einen längeren Zeitraum nicht benutzt, sollten Sie es vom Stromnetz trennen. Somit wird im Falle einer Überspannung eine Beschädigung vermieden.
12. Durch die Lüftungsöffnungen dürfen niemals Gegenstände oder Flüssigkeiten in das Gerät gelangen. Dies könnte einen Brand bzw. elektrischen Schlag auslösen.
13. Öffnen Sie niemals das Gerät. Das Gerät darf aus Gründen der elektrischen Sicherheit nur von autorisiertem Servicepersonal geöffnet werden.
14. Wenn folgende Situationen auftreten ist das Gerät vom Stromnetz zu trennen und von einer qualifizierten Servicestelle zu überprüfen:
 15. Netzkabel oder Netzstecker sind beschädigt.
 16. Flüssigkeit ist in das Gerät eingedrungen.
 17. Das Gerät war Feuchtigkeit ausgesetzt.
18. Wenn das Gerät nicht der Bedienungsanleitung entsprechend funktioniert oder Sie mit Hilfe dieser Anleitung keine Verbesserung erzielen.
19. Das Gerät ist gefallen und/oder das Gehäuse ist beschädigt.
20. Wenn das Gerät deutliche Anzeichen eines Defektes aufweist.
21. **VORSICHT:** Explisionsgefahr bei unsachgemaben Austausch der Batterie.Ersatz nur durch denselben oder einem vom Hersteller empfohlene-mahnlichen Typ. Entsorgung gebrauchter Batterien navh Angaben des Herstellers.
22. **ACHTUNG:** Es besteht die Explosionsgefahr, falls die Batterie auf nicht fachmännische Weise gewechselt wird. Verfangan Sie die Batterie nur gleicher oder entsprechender Type, wie vom Hersteller empfohlen. Entsorgen Sie Batterien nach Anweisung des Herstellers.
23. Der arbeitsplatzbezogene Schalldruckpegel nach DIN 45 635 Teil 1000 beträgt 70dB(A) oder weiger.

Haftungsausschluss: Die Bedienungsanleitungen wurden entsprechend der IEC-704-1 erstellt. Advantech lehnt jegliche Verantwortung für die Richtigkeit der in diesem Zusammenhang getätigten Aussagen ab.

Safety Precaution - Static Electricity

Static electricity can cause bodily harm or damage electronic devices. To avoid damage, keep static-sensitive devices in the static-protective packaging until the installation period. The following guidelines are also recommended:

- Wear a grounded wrist or ankle strap and use gloves to prevent direct contact to the device before servicing the device. Avoid nylon gloves or work clothes, which tend to build up a charge.
- Always disconnect the power from the device before servicing it.
- Before plugging a cable into any port, discharge the voltage stored on the cable by touching the electrical contacts to the ground surface.

Contents

Chapter 1	Product Overview	1
1.1	Specifications	2
1.2	Hardware Views	3
1.2.1	Front View	3
1.2.2	Rear View	5
1.3	Dimensions	6
Chapter 2	Switch Installation	7
2.1	Warnings	8
2.2	Installation Guidelines	10
2.3	Environment and Enclosure Guidelines	10
2.3.1	Connecting Hardware	10
2.4	Verifying Switch Operation	11
2.5	Installing the Switch	11
2.5.1	Rack-Mounting	11
2.6	Installing and Removing SFP Modules	12
2.6.1	Installing SFP Modules	12
2.6.2	Removing SFP Modules	14
2.7	Connecting the Switch to Ethernet Ports	15
2.7.1	RJ45 Ethernet Cable Wiring	15
2.8	Connecting the Switch to Console Port	16
2.9	Power Supply Installation	17
2.9.1	Overview	17
2.9.2	Considerations	18
2.9.3	Grounding the Device	18
2.9.4	Wiring a Relay Contact	19
2.9.5	Wiring the Power Inputs	20
2.10	Reset Button	21
Chapter 3	Configuration Utility	22
3.1	First Time Setup	23
3.1.1	Overview	23
3.1.2	Introduction	23
3.1.3	Administrative Interface Access	23
3.2	Command Line Interface Configuration	26
3.2.1	Introduction to Command-Line Interface (CLI)	26
3.2.2	Accessing the CLI	26
3.3	Web Browser Configuration	27
3.3.1	Preparing for Web Configuration	27
3.3.2	System Login	27
Chapter 4	Managing Switch	28
4.1	Log In	29
4.2	Recommended Practices	29
4.2.1	Changing Default Password	29
4.3	Monitoring	30
4.3.1	Device Information	30
4.3.2	Logging Message	31
4.3.3	Port Monitoring	32

	4.3.4	Link Aggregation.....	34
	4.3.5	LLDP Statistics.....	34
	4.3.6	IGMP Statistics.....	35
	4.3.7	MLD Statistics.....	36
4.4		System.....	38
	4.4.1	IP Settings.....	38
	4.4.2	IPv6 Settings.....	39
	4.4.3	DHCP Client Option 82.....	39
	4.4.4	DHCP Auto Provision.....	41
	4.4.5	Management VLAN.....	41
	4.4.6	System Time.....	42
	4.4.7	Network Port.....	43
4.5		L2 Switching.....	45
	4.5.1	Port Configuration.....	45
	4.5.2	Port Mirror.....	46
	4.5.3	Link Aggregation.....	47
	4.5.4	802.1Q VLAN.....	51
	4.5.5	Q-in-Q.....	55
	4.5.6	GARP.....	57
	4.5.7	802.3az EEE.....	58
	4.5.8	Multicast.....	59
	4.5.9	Jumbo Frame.....	64
	4.5.10	Spanning Tree.....	64
	4.5.11	X-Ring Elite.....	70
	4.5.12	X-Ring Pro.....	71
	4.5.13	Loopback Detection.....	74
	4.5.14	ERPS.....	75
4.6		MAC Address Table.....	77
	4.6.1	Static MAC.....	77
	4.6.2	MAC Aging Time.....	77
	4.6.3	Dynamic Forwarding Table.....	78
4.7		Security.....	79
	4.7.1	Storm Control.....	79
	4.7.2	Port Security.....	80
	4.7.3	Protected Ports.....	81
	4.7.4	DoS Prevention.....	81
	4.7.5	Applications.....	84
	4.7.6	802.1x.....	86
	4.7.7	IP Security.....	87
	4.7.8	Security Login.....	89
	4.7.9	Access Control List.....	91
	4.7.10	IP Source Guard.....	94
	4.7.11	DHCP Snooping.....	96
	4.7.12	ARP Spoofing.....	99
4.8		QoS.....	100
	4.8.1	General.....	100
	4.8.2	QoS Basic Mode.....	105
	4.8.3	Rate Limit.....	107
	4.8.4	Bandwidth Guarantee.....	109
4.9		Management.....	111
	4.9.1	LLDP.....	111
	4.9.2	SNMP.....	115
	4.9.3	Power Over Ethernet.....	118
	4.9.4	TCP Modbus Settings.....	120
	4.9.5	DHCP Server.....	121
	4.9.6	SMTP Client.....	125
	4.9.7	RMON.....	127
	4.9.8	NTP Server.....	131
4.10		Diagnostics.....	132
	4.10.1	Cable Diagnostics.....	132

	4.10.2 Ping Test.....	132
	4.10.3 IPv6 Ping Test.....	133
	4.10.4 System Log.....	135
	4.10.5 DDM.....	137
	4.10.6 LED Indication.....	138
4.11	Tools	139
	4.11.1 IXM.....	139
	4.11.2 Backup Manager	139
	4.11.3 Upgrade Manager	140
	4.11.4 Dual Image.....	141
	4.11.5 Save Configuration	142
	4.11.6 User Account	142
	4.11.7 N-Key.....	143
	4.11.8 Reset System.....	143
	4.11.9 Reboot Device	143
4.12	Modbus/TCP Mapping	144
	4.12.1 Modbus/TCP Mapping Table	144

Chapter 5 Troubleshooting 156

5.1	Troubleshooting	157
-----	-----------------------	-----

List of Figures

Figure 1.1	Front View	3
Figure 1.2	Front View	3
Figure 1.3	System LED Panel	4
Figure 1.4	Rear View	5
Figure 1.5	Rear View	5
Figure 1.6	EKI-7428G-4CI Dimensions	6
Figure 1.7	EKI-7428G-4CPI Dimensions	6
Figure 2.1	Installing the Rack Mount Brackets	11
Figure 2.2	Installing the Switch	11
Figure 2.3	Removing the Dust Plug from an SFP Slot	12
Figure 2.4	Installing an SFP Transceiver	13
Figure 2.5	Attaching a Fiber Optic Cable to a Transceiver	13
Figure 2.6	Removing a Fiber Optic Cable to a Transceiver	14
Figure 2.7	Removing an SFP Transceiver	14
Figure 2.8	Ethernet Plug & Connector Pin Position	15
Figure 2.9	Serial Console Cable	16
Figure 2.10	DB 9 Pin Position	16
Figure 2.11	Pin Assignment	16
Figure 2.12	Power Wiring for EKI-7428 Series	17
Figure 2.13	Grounding Connection	19
Figure 2.14	Terminal Receptor: Relay Contact	19
Figure 2.15	Terminal Receptor: Power Input Contacts	20
Figure 2.16	Installing DC Wires in a Terminal Block	20
Figure 4.1	Login Screen	29
Figure 4.2	Changing a Default Password	30
Figure 4.3	Monitoring > Device Information	30
Figure 4.4	Monitoring > Logging Message	31
Figure 4.5	Monitoring > Logging Information	32
Figure 4.6	Monitoring > Logging Message	32
Figure 4.7	Monitoring > Port Monitoring > Port Statistics	32
Figure 4.8	Monitoring > Port Monitoring > IF MIB Counters	33
Figure 4.9	Monitoring > Port Monitoring > Ether-Like MIB Counters	33
Figure 4.10	Monitoring > Port Monitoring > Ether-Like MIB Counters	33
Figure 4.11	Monitoring > Port Monitoring > Port Utilization	33
Figure 4.12	Monitoring > Port Monitoring > Port Error Disable	34
Figure 4.13	Monitoring > Link Aggregation	34
Figure 4.14	Monitoring > LLDP Statistics	35
Figure 4.15	Monitoring > LLDP Port Statistics	35
Figure 4.16	Monitoring > IGMP Statistics	36
Figure 4.17	Monitoring > MLD Statistics	37
Figure 4.18	System > IP Settings	38
Figure 4.19	System > IP Address Information	38
Figure 4.20	System > IPv6 Settings	39
Figure 4.21	System > IPv6 Information	39
Figure 4.22	System > DHCP Client Option 82	40
Figure 4.23	System > DHCP Client Option 82 Information	41
Figure 4.24	System > DHCP Auto Provision	41
Figure 4.25	System > DHCP Auto Provision Information	41
Figure 4.26	System > Management VLAN	42
Figure 4.27	System > System Time	42
Figure 4.28	System > System Time Information	43
Figure 4.29	System > Network Port	43
Figure 4.30	L2 Switching > Port Configuration	45
Figure 4.31	L2 Switching > Port Name Settings	45
Figure 4.32	L2 Switching > Port Status	46
Figure 4.33	L2 Switching > Port Mirror	46

Figure 4.34	L2 Switching > RSPAN.....	47
Figure 4.35	L2 Switching > Mirror Status.....	47
Figure 4.36	L2 Switching > Link Aggregation > Load Balance	47
Figure 4.37	L2 Switching > Link Aggregation > Load Balance Information	48
Figure 4.38	L2 Switching > Link Aggregation > LAG Management.....	48
Figure 4.39	L2 Switching > Link Aggregation > LAG Management Information.....	49
Figure 4.40	L2 Switching > Link Aggregation > LAG Port Settings	49
Figure 4.41	L2 Switching > Link Aggregation > LAG Port Status	50
Figure 4.42	L2 Switching > Link Aggregation > LACP Priority Settings	50
Figure 4.43	L2 Switching > Link Aggregation > LACP Port Settings.....	50
Figure 4.44	L2 Switching > Link Aggregation > LACP Port Information Settings.....	51
Figure 4.45	L2 Switching > 802.1Q VLAN > VLAN Management	52
Figure 4.46	L2 Switching > 802.1Q VLAN > VLAN Table	52
Figure 4.47	L2 Switching > 802.1Q VLAN > PVID Settings	52
Figure 4.48	L2 Switching > 802.1Q VLAN > Port to VLAN.....	54
Figure 4.49	L2 Switching > 802.1Q VLAN > Port-VLAN Mapping.....	55
Figure 4.50	L2 Switching > 802.1Q VLAN > RSPAN VLAN Mapping	55
Figure 4.51	L2 Switching > Q-in-Q > Global Settings.....	56
Figure 4.52	L2 Switching > Q-in-Q > Port Settings.....	56
Figure 4.53	L2 Switching > QinQ Port Information	57
Figure 4.54	L2 Switching > GARP > GARP Settings.....	57
Figure 4.55	L2 Switching > GARP > GVRP Settings.....	58
Figure 4.56	L2 Switching > GARP > GMRP Settings	58
Figure 4.57	L2 Switching > 802.3az EEE	59
Figure 4.58	L2 Switching > Multicast > Multicast Filtering.....	59
Figure 4.59	L2 Switching > Multicast > IGMP Snooping > IGMP Settings	60
Figure 4.60	L2 Switching > Multicast > IGMP Snooping > IGMP Snooping Information.....	60
Figure 4.61	L2 Switching > Multicast > IGMP Snooping > IGMP Querier	60
Figure 4.62	L2 Switching > Multicast > IGMP Snooping > IGMP Querier Status	61
Figure 4.63	L2 Switching > Multicast > IGMP Snooping > IGMP Static Groups	61
Figure 4.64	L2 Switching > Multicast > IGMP Snooping > Multicast Groups	61
Figure 4.65	L2 Switching > Multicast > IGMP Snooping > Router Ports	61
Figure 4.66	L2 Switching > Multicast > MLD Snooping > MLD Settings	62
Figure 4.67	L2 Switching > Multicast > MLD Snooping > MLD Snooping Information	62
Figure 4.68	L2 Switching > Multicast > MLD Snooping > MLD Snooping Table	62
Figure 4.69	L2 Switching > Multicast > MLD Snooping > MLD Querier	63
Figure 4.70	L2 Switching > Multicast > MLD Snooping > MLD Static Group	63
Figure 4.71	L2 Switching > Multicast > MLD Snooping > Multicast Groups.....	64
Figure 4.72	L2 Switching > Multicast > MLD Snooping > Router Ports.....	64
Figure 4.73	L2 Switching > Jumbo Frame.....	64
Figure 4.74	L2 Switching > Spanning Tree > STP Global Settings.....	65
Figure 4.75	L2 Switching > Spanning Tree > STP Information	65
Figure 4.76	L2 Switching > Spanning Tree > STP Port Settings.....	66
Figure 4.77	L2 Switching > Spanning Tree > STP Bridge Settings.....	67
Figure 4.78	L2 Switching > Spanning Tree > STP Port Advanced Settings.....	67
Figure 4.79	L2 Switching > Spanning Tree > STP Port Status.....	68
Figure 4.80	L2 Switching > Spanning Tree > MST Config Identification	68
Figure 4.81	L2 Switching > Spanning Tree > MST ID Settings	69
Figure 4.82	L2 Switching > Spanning Tree > MSTI Priority Settings.....	69
Figure 4.83	L2 Switching > Spanning Tree > STP Bridge Status.....	70
Figure 4.84	L2 Switching > Spanning Tree > MSTI Port Advanced settings.....	70
Figure 4.85	L2 Switching > Spanning Tree > STP Statistics	70
Figure 4.86	L2 Switching > X-Ring Elite > X-Ring Elite Settings	71
Figure 4.87	L2 Switching > X-Ring Elite > X-Ring Elite Groups	71
Figure 4.88	L2 Switching > X-Ring Pro > X-Ring Pro Settings.....	72
Figure 4.89	L2 Switching > X-Ring Pro > X-Ring Pro Groups > X-Ring Pro Groups Settings.....	72
Figure 4.90	L2 Switching > X-Ring Pro > X-Ring Pro Groups > Chain Settings.....	72
Figure 4.91	L2 Switching > X-Ring Pro > X-Ring Pro Groups > Couple Setting	73
Figure 4.92	L2 Switching > X-Ring Pro > X-Ring Pro Groups > Pair Settings.....	73
Figure 4.93	L2 Switching > X-Ring Pro > X-Ring Pro Groups > RPair Settings.....	73

Figure 4.94	L2 Switching > Loopback Detection > Global Settings.....	74
Figure 4.95	L2 Switching > Loopback Detection > Loopback Detection Global Information.....	74
Figure 4.96	L2 Switching > Loopback Detection > Port Settings	75
Figure 4.97	L2 Switching > ERPS > ERPS Settings	75
Figure 4.98	L2 Switching > ERPS > ERPS Groups	76
Figure 4.99	MAC Address Table > Static MAC	77
Figure 4.100	MAC Address Table > Static MAC Status.....	77
Figure 4.101	MAC Address Table > MAC Aging Time.....	77
Figure 4.102	MAC Address Table > Dynamic Forwarding Table	78
Figure 4.103	MAC Address Table > MAC Address Information.....	78
Figure 4.104	Security > Storm Control > Global Settings.....	79
Figure 4.105	Security > Storm Control > Storm Control Global Information	79
Figure 4.106	Security > Storm Control > Port Settings	80
Figure 4.107	Security > Storm Control > Storm Control Port Information	80
Figure 4.108	Security > Port Security.....	81
Figure 4.109	Security > Protected Ports.....	81
Figure 4.110	Security > DoS Prevention > DoS Global Settings.....	82
Figure 4.111	Security > Storm Control > DoS Global Information.....	83
Figure 4.112	Security > DoS Prevention > DoS Port Settings	84
Figure 4.113	Security > Applications > TELNET	84
Figure 4.114	Security > Applications > SSH	85
Figure 4.115	Security > Applications > HTTP	85
Figure 4.116	Security > Applications > HTTPS.....	86
Figure 4.117	Security > 802.1x > 802.1x Global Settings	86
Figure 4.118	Security > 802.1x > 802.1x Information.....	87
Figure 4.119	Security > 802.1x > 802.1x Port Configuration.....	87
Figure 4.120	Security > IP Security > Global Settings	88
Figure 4.121	Security > IP Security > Entry Settings	88
Figure 4.122	Security > Security Login > Global Settings > Global Settings.....	89
Figure 4.123	Security > Security Login > Global Settings > RADIUS Settings	89
Figure 4.124	Security > Security Login > Global Settings > TACACS Settings	90
Figure 4.125	Security > Security Login > Global Settings > Global Information.....	90
Figure 4.126	Security > Security Login > Access Control Settings > Security Login Type Settings	90
Figure 4.127	Security > Security Login > Access Control Settings > Security Login Type Settings	91
Figure 4.128	Security > Security Login > Access Control Settings > Access Control Information...	91
Figure 4.129	Security > Access Control List > MAC ACL > Entry Settings.....	92
Figure 4.130	Security > Access Control List > MAC ACL > Entry List	93
Figure 4.131	Security > Access Control List > IP ACL > Entry Settings.....	93
Figure 4.132	Security > Access Control List > IP ACL > Entry List	94
Figure 4.133	Security > IP Source Guard > Global Settings.....	94
Figure 4.134	Security > IP Source Guard > Global Information	95
Figure 4.135	Security > IP Source Guard > Entry Settings	95
Figure 4.136	Security > IP Source Guard > Entry Information	95
Figure 4.137	Security > DHCP Snooping > Global Settings > DHCP Snooping State Settings.....	96
Figure 4.138	Security > DHCP Snooping > Global Settings > DHCP Snooping Port Settings	96
Figure 4.139	Security > DHCP Snooping > Global Settings > DHCP Snooping Binding Port Settings	96
Figure 4.140	Security > DHCP Snooping > Global Settings > DHCP Snooping Information.....	97
Figure 4.141	Security > DHCP Snooping > Entry Settings > Entry Information.....	97
Figure 4.142	Security > DHCP Snooping > L2-Relay Settings	97
Figure 4.143	Security > DHCP Snooping > L2-Relay Port Settings.....	97
Figure 4.144	Security > DHCP Snooping > L2-Relay VLAN Settings	98
Figure 4.145	Security > DHCP Snooping > Circuit ID Settings.....	98
Figure 4.146	Security > DHCP Snooping > L2 Relay Information.....	98
Figure 4.147	Security > ARP Spoofing.....	99
Figure 4.148	Security > Entry Information.....	99
Figure 4.149	QoS > General > QoS Properties.....	100
Figure 4.150	QoS > General > QoS Settings	100
Figure 4.151	QoS > General > QoS Status.....	101
Figure 4.152	QoS > General > QoS Scheduling	102

Figure 4.153	QoS > General > QoS Information	102
Figure 4.154	QoS > General > CoS Mapping.....	103
Figure 4.155	QoS > General > CoS Mapping.....	103
Figure 4.156	QoS > General > CoS Mapping.....	104
Figure 4.157	QoS > General > DSCP Mapping.....	104
Figure 4.158	QoS > General > IP Precedence Mapping	105
Figure 4.159	QoS > QoS Basic Mode > Global Settings.....	106
Figure 4.160	QoS > General > Global Settings	106
Figure 4.161	QoS > QoS Basic Mode > Port Settings.....	106
Figure 4.162	QoS > Rate Limit > Ingress Bandwidth Control	107
Figure 4.163	QoS > Rate Limit > Ingress Bandwidth Control	107
Figure 4.164	QoS > Rate Limit > Ingress Bandwidth Control	107
Figure 4.165	QoS > Rate Limit > Egress Bandwidth Control	108
Figure 4.166	QoS > Rate Limit > Egress Bandwidth Control	108
Figure 4.167	QoS > Rate Limit > Egress Queue	108
Figure 4.168	QoS > Bandwidth Guarantee > Global Settings	109
Figure 4.169	QoS > Bandwidth Guarantee > Global Settings	110
Figure 4.170	QoS > Bandwidth Guarantee > Utilization.....	110
Figure 4.171	Management > LLDP > LLDP System Settings	111
Figure 4.172	Management > LLDP > LLDP System Settings	111
Figure 4.173	Management > LLDP > LLDP Port Settings > LLDP Port Configuration.....	112
Figure 4.174	Management > LLDP > LLDP Port Settings > Optional TLVs Selection	112
Figure 4.175	Management > LLDP > LLDP Port Settings > VLAN Name TLV VLAN Selection	113
Figure 4.176	Management > LLDP > LLDP Local Device Info	114
Figure 4.177	Management > LLDP > LLDP Local Device Info	114
Figure 4.178	Management > LLDP > LLDP Remote Device Info.....	114
Figure 4.179	Management > LLDP > LLDP Overloading	115
Figure 4.180	Management > SNMP > SNMP Settings.....	115
Figure 4.181	Management > SNMP > SNMP Community	116
Figure 4.182	Management > SNMP > SNMP Community	116
Figure 4.183	Management > SNMP > SNMPv3 EngineID	116
Figure 4.184	Management > SNMP > SNMPv3 Settings.....	117
Figure 4.185	Management > SNMP > SNMP Trap	118
Figure 4.186	Management > Power Over Ethernet > PoE System Settings	119
Figure 4.187	Management > Power Over Ethernet > PoE Port Settings	119
Figure 4.188	Management > TCP Modbus Settings > TCP Modbus Settings	120
Figure 4.189	Management > TCP Modbus Settings > TCP Modbus Settings	120
Figure 4.190	Management > DHCP Server > Status Settings	121
Figure 4.191	Management > DHCP Server > Global Settings	121
Figure 4.192	Management > DHCP Server > Global Settings	122
Figure 4.193	Management > DHCP Server > Port Settings.....	122
Figure 4.194	Management > DHCP Server > Option 82 Settings	123
Figure 4.195	Management > DHCP Server > Option 82 Settings	124
Figure 4.196	Management > DHCP Server > Client MAC Settings	124
Figure 4.197	Management > DHCP Server > Lease Entry	125
Figure 4.198	Management > SMTP Client > Global Settings.....	125
Figure 4.199	Management > SMTP Client > Profile Settings > Profile Settings.....	125
Figure 4.200	Management > SMTP Client > Profile Settings > Profile Target Mail Settings.....	126
Figure 4.201	Management > DHCP Server > Lease Entry	126
Figure 4.202	Management > SMTP Client > Sending Message	127
Figure 4.203	Management > RMON > RMON Statistics	127
Figure 4.204	Management > RMON > RMON History	128
Figure 4.205	Management > RMON > RMON Alarm	129
Figure 4.206	Management > RMON > RMON Event	130
Figure 4.207	Management > NTP Server.....	131
Figure 4.208	Diagnostics > Cable Diagnostics.....	132
Figure 4.209	Diagnostics > Ping Test.....	132
Figure 4.210	Diagnostics > IPv6 Ping Test.....	134
Figure 4.211	Diagnostics > System Log > Logging Service	135
Figure 4.212	Diagnostics > System Log > Local Logging	135

Figure 4.213	Diagnostics > System Log > System Log Server	136
Figure 4.214	Diagnostics > DDM > Diagnostic Alarm Settings	137
Figure 4.215	Diagnostics > DDM > DMI INFO	137
Figure 4.216	Diagnostics > LED Indication	138
Figure 4.217	Diagnostics > LED Indication	138
Figure 4.218	Tools > IXM	139
Figure 4.219	Tools > Backup Manager	140
Figure 4.220	Tools > Upgrade Manager.....	141
Figure 4.221	Tools > Dual Image	141
Figure 4.222	Tools > User Account	142
Figure 4.223	Tools > User Account	142
Figure 4.224	Tools > User Account	143
Figure 4.225	Tools > N-Key	143
Figure 4.226	Tools > N-Key Information.....	143

Chapter 1

Product Overview

1.1 Specifications

Specifications	Description		
Interface	I/O Port	24 x RJ45 + 4 x Combo (RJ45/Fiber)	
	Power Connector	<ul style="list-style-type: none"> ■ 4-pin removable screw terminal (power) ■ 3-pin removable screw terminal (relay) 	
Physical	Enclosure	Metal Shell	
	Protection Class	IP30	
	Installation	Rack mounting	
	Dimensions (W x H x D)	438.0 x 43.6 x 259.2 mm (17.24 x 1.72 x 10.2 in.)	
LED Display	System LED	SYS, PWR1, PWR2, P-Fail, LOOP, R.M., R-FAIL, Temp	
	Port LED	Speed, Link, Activity, PoE (only for EKI-7428G-4CPI)	
Environment	Operating Temperature	-40°C ~ 70°C (-40°F ~ 158°F)	
	Storage Temperature	-40°C ~ 85°C (-40°F ~ 185°F)	
	Ambient Relative Humidity	10 ~ 95% (non-condensing)	
Switch Properties	MAC Address	8K-entry	
	Switch Capacity	56 Gbps	
Power	Power Consumption	<ul style="list-style-type: none"> ■ EKI-7428G-4CI: 20W @ 24V ■ EKI-7428G-4CPI: 20W @ 48V 	
	Power Input	<ul style="list-style-type: none"> ■ EKI-7428G-4CI: 12V~48VDC ■ EKI-7428G-4CPI: 48VDC (46 - 57 VDC) for PoE system (53 - 57 VDC is recommended for PoE+ devices) 	
Certifications	Safety	UL 61010-2-201	
	EMC	CE, FCC	
	EMI	EN55022 Class A	
	EMS	<ul style="list-style-type: none"> ■ EN 61000-4-2 (ESD) Level 3 ■ EN 61000-4-3 (RS) Level 3 ■ EN 61000-4-4 (EFT) Level 3 ■ EN 61000-4-5 (Surge) Level 3 ■ EN 61000-4-6 (CS) Level 3 ■ EN 61000-4-8 (Magnetic Field) Level 3 	
	Shock	IEC 60068-2-27	
Freefall	IEC 60068-2-32		
Vibration	IEC 60068-2-6		
Railway Track Side	EN 50121-4		

1.2 Hardware Views

1.2.1 Front View

The following view applies to EKI-7428G-4CI.

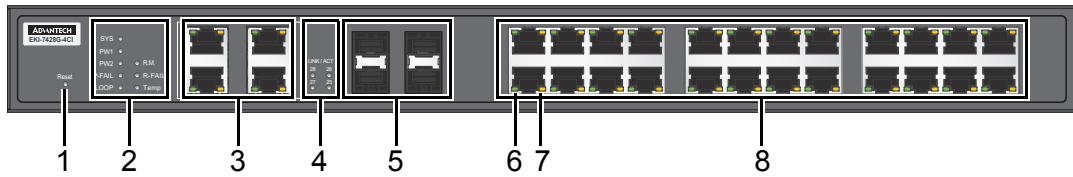

Figure 1.1 Front View

No.	Item	Description
1	Reset button	Button allows for system soft reset (3 sec.) or factory default reset (5 sec.).
2	System LED panel	See "System LED Panel" on page 4 for further details.
3	ETH port	RJ45 combo x 4
4	SFP LEDs	SFP link activity LEDs
5	ETH port	Fiber combo x 4
6	LNK/ACT LED	Link activity LED
7	Speed LED	<ul style="list-style-type: none"> ■ Green: 1000M ■ Orange: 100M ■ None: 10M
8	ETH port	RJ45 ports x 24

The following view applies to EKI-7428G-4CPI.

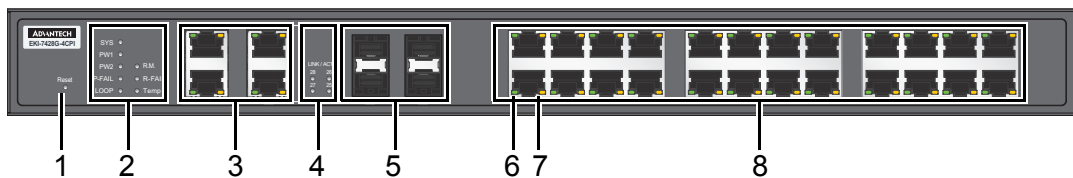

Figure 1.2 Front View

No.	Item	Description
1	Reset button	Button allows for system soft reset (3 sec.) or factory default reset (5 sec.).
2	System LED panel	See "System LED Panel" on page 4 for further details.
3	ETH port	RJ45 ports x 4
4	SFP LEDs	SFP link activity LEDs
5	ETH port	Fiber ports x 4
6	PoE LED	Link activity LED
7	LNK/ACT LED	<ul style="list-style-type: none"> ■ Green: 1000M ■ Orange: 10/100M
8	ETH port	RJ45 ports x 24

1.2.1.1 System LED Panel

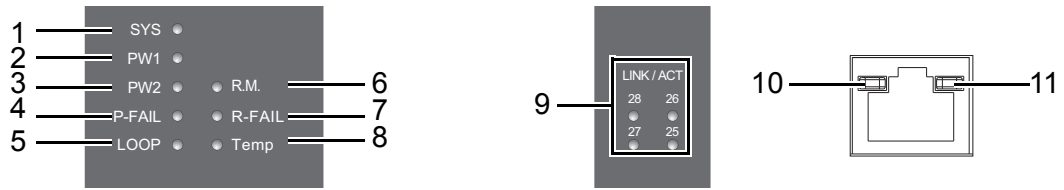

Figure 1.3 System LED Panel

No.	LED Name	LED Color	Description
1	SYS	Solid green	System is operating normally.
		Off	System is powered down / system crash / operation initiating.
2	PWR1	Solid green	Powered up.
		Off	Powered down or not installed.
3	PWR2	Solid green	Powered up.
		Off	Power down or not installed.
4	P-FAIL	Solid red	When PW1 or PW2 is disconnected, the LED lights.
		Off	When PW1 and PW2 is connected, the LED is off.
5	LOOP	Solid red	When loop detected, the LED lights.
		Off	No loop detected.
6	R. M. (Ring Master)	Solid green	An active switch within the ring is a designated ring master.
		Off	No ring master determined in current ring.
7	R-FAIL	Solid red	A ring port within the ring loop is identified has having a ring ID within a second ring loop.
		Off	No ring ports having a ring ID within a secondary ring loop are detected.
8	Temp	Solid red	IC sensor detects a temperature range exceeding set temperature range.
		Off	IC sensor detects normal operating temperature.
SFP			
9	SFP LED	Solid green	SFP or GBIC plug-in and link up.
		Blink green	Packet transmit and receive.
		Off	SFP or GBIC plug-out or link down.
RJ45			
10	PoE	Solid green	Connect to PD and supply power.
		Blink green	Not applicable.
		Off	Disconnect from PD and No supply Power.
11	LNK/ACT	Solid green	Current link speed is 1000M.
		Blink green	Packet transmit and receive.
		Off	No link.
		Solid amber	Current link speed is 100/10M.
		Blink amber	Packet transmit and receive.
		Off	No link.
	Solid green	Connect to PD and supply power.	

1.2.2 Rear View

The following view applies to EKI-7428G-4CI.

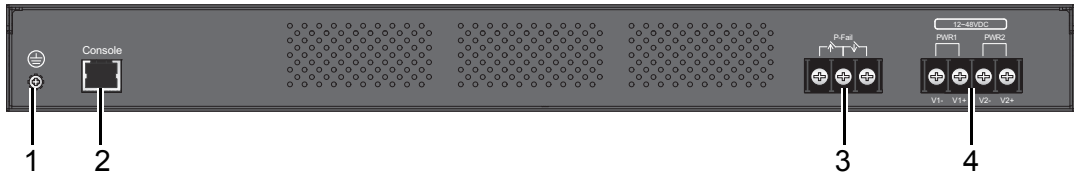

Figure 1.4 Rear View

No.	Item	Description
1	Ground terminal	Screw terminal used to ground chassis.
2	Console serial port	Console cable port to COM port (DB9 male) on computer to RS232 managed switch (RJ45 female).
3	P-Fail block	An open circuit occurs upon detecting a power failure. A close circuit denotes normal power activity.
4	Power block	Connect cabling for power wiring.

The following view applies to EKI-7428G-4CPI.

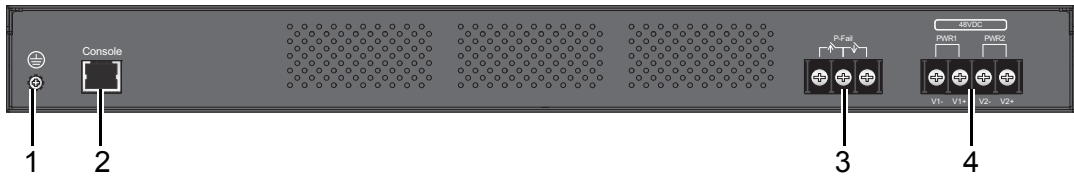

Figure 1.5 Rear View

No.	Item	Description
1	Ground terminal	Screw terminal used to ground chassis.
2	Console serial port	Console cable port to COM port (DB9 male) on computer to RS232 managed switch (RJ45 female).
3	P-Fail block	An open circuit occurs upon detecting a power failure. A close circuit denotes normal power activity.
4	Power block	Connect cabling for power wiring.

1.3 Dimensions

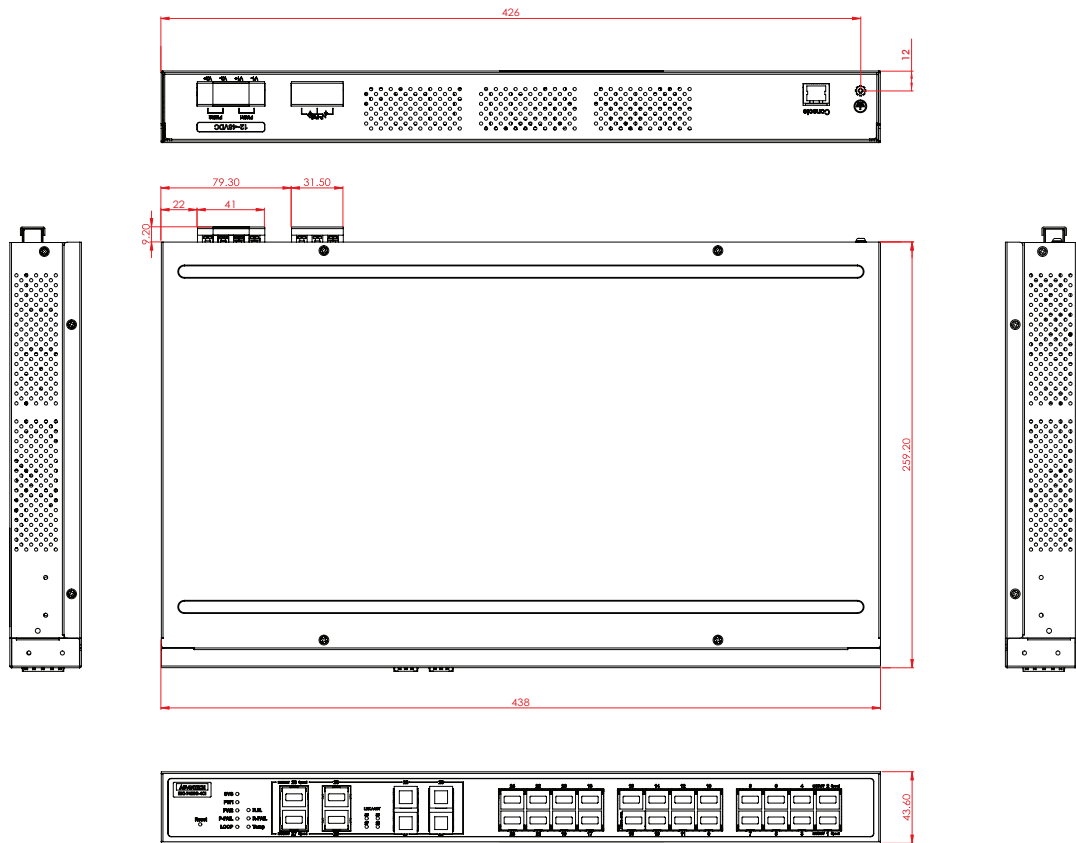

Figure 1.6 EKI-7428G-4CI Dimensions

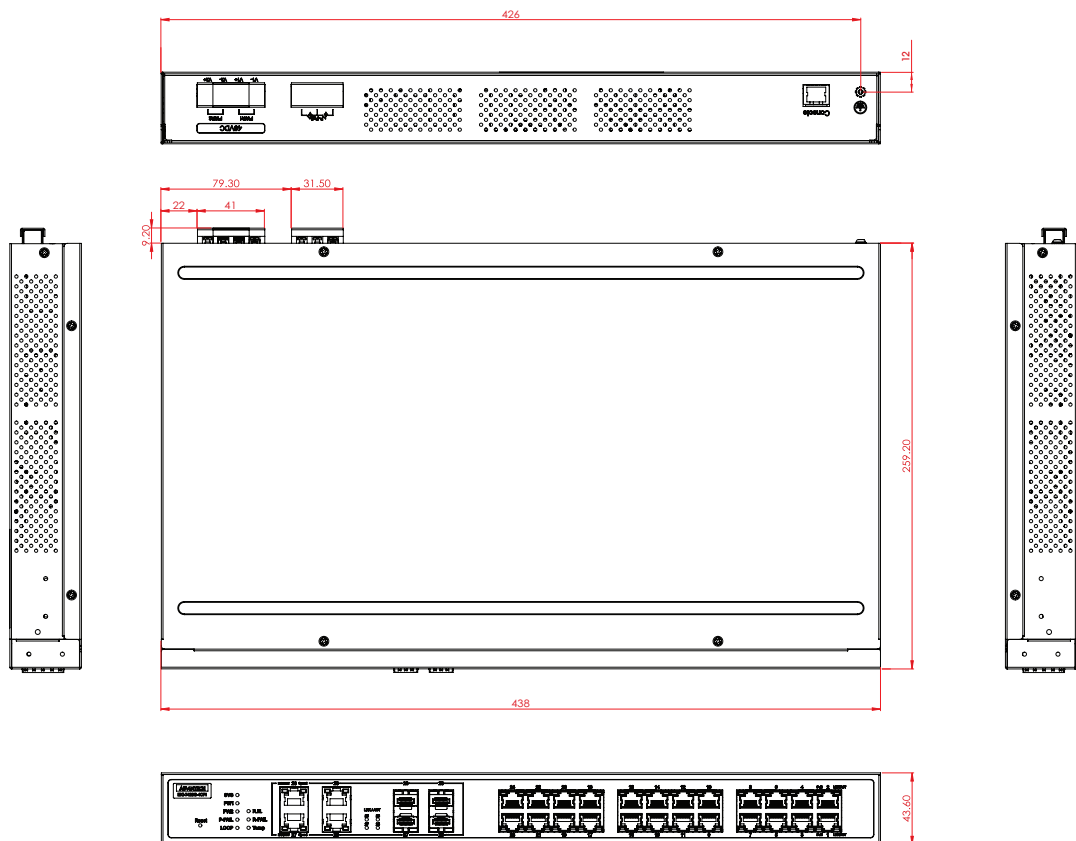

Figure 1.7 EKI-7428G-4CPI Dimensions

Chapter 2

Switch Installation

2.1 Warnings

Warning: Before working on equipment that is connected to power lines, remove any jewelry (including rings, necklaces, and watches). Metal objects can heat up when connected to power and ground, which can cause serious burns or weld the metal object to the terminals.

Caution! *Exposure to chemicals can degrade the sealing properties of materials used in the sealed relay device.*



Caution! *It is not recommended to work on the system or connect or disconnect cables during periods of lightning activity.*



Caution! *Before performing any of the following procedures, disconnect the power source from the DC circuit.*



Caution! *Read the installation instructions before connecting the system to its power source.*



Caution! *The device must be grounded. Never defeat the ground conductor or operate the equipment in the absence of a suitably installed ground conductor.*



Caution! *This unit may have more than one power supply connection. All connections must be removed to de-energize the unit.*



Caution! *The installation, replacement, or service of the device must be Only be performed by trained and qualified personnel.*



Caution! *Ultimate disposal of this product should be handled according to local and national regulations*



Caution! *To prevent the system from overheating, do not operate it in an area that exceeds the maximum recommended ambient temperature of: 70°C (158°F).*



Caution! *If the switch is to be installed in a hazardous location, ensure that the DC power source is located away from the vicinity of the switch.*



Caution! *The installation of the equipment must comply with all national and local electrical codes.*



Caution! *Explosion Hazard-The area must be known to be nonhazardous before servicing or replacing any components.*



Warning! *Airflow around the switch must be unrestricted. To prevent the switch from overheating, there must be the following minimum clearances:*



- Top and bottom: 2.0 in. (50.8 mm)
- Sides: 2.0 in. (50.8 mm)
- Front: 2.0 in. (50.8 mm)

2.2 Installation Guidelines

The following guidelines are provided to optimize the device performance. Review the guidelines before installing the device.

- Make sure cabling is away from sources of electrical noise. Radios, power lines, and fluorescent lighting fixtures can interfere with the device performance.
- Make sure the cabling is positioned away from equipment that can damage the cables.
- Operating environment is within the ranges listed range, see “Specifications” on page 2.
- Relative humidity around the switch does not exceed 95 percent (noncondensing).
- Altitude at the installation site is not higher than 10,000 feet.
- In 10/100 and 10/100/1000 fixed port devices, the cable length from the switch to connected devices can not exceed 100 meters (328 feet).
- Make sure airflow around the switch and respective vents is unrestricted. Without proper airflow the switch can overheat. To prevent performance degradation and damage to the switch, make sure there is clearance at the top and bottom and around the exhaust vents.

2.3 Environment and Enclosure Guidelines

Review these environmental and enclosure guidelines before installation:

This equipment is intended for use in a Pollution Degree 2 industrial environment, in overvoltage Category II applications (as defined in IEC publication 60664-1), at altitudes up to 9842 ft (3 km) without derating.

This equipment is considered Group 1, Class A industrial equipment, according to IEC/CISPR Publication 11. Without appropriate precautions, there may be potential difficulties ensuring electromagnetic compatibility in other environments due to conducted as well as radiated disturbance.

This equipment is supplied as open-type equipment. It must be mounted within an enclosure that is suitably designed for those specific environmental conditions that will be present and appropriately designed to prevent personal injury resulting from accessibility to live parts. The enclosure must have suitable flame-retardant properties to prevent or minimize the spread of flame, complying with a flame-spread rating of 5VA, V2, V1, V0 (or equivalent) if nonmetallic. The interior of the enclosure must be accessible only by the use of a tool. Subsequent sections of this publication might contain additional information regarding specific enclosure-type ratings that are required to comply with certain product safety certifications.

2.3.1 Connecting Hardware

In this instruction, it will explain how to find a proper location for your Modbus Gateways, and how to connect to the network, hook up the power cable, and connect to the EKI-7428 Series.

2.4 Verifying Switch Operation

Before installing the device in a rack or on a wall, power on the switch to verify that the switch passes the power-on self-test (POST). To connect the cabling to the power source see “Power Supply Installation” on page 17.

At startup (POST), the System LED blinks green, while the remaining LEDs are a solid green. Once the switch passes POST self-test, the System LED turns green. The other LEDs turn off and return to their operating status. If the switch fails POST, the System LED switches to an amber state.

After a successful self-test, power down the switch and disconnect the power cabling. The switch is now ready for installation on its final location.

2.5 Installing the Switch

2.5.1 Rack-Mounting

1. Align the rack mount brackets with the holes on the switch.
2. Secure the rack mount brackets with the provided screws.

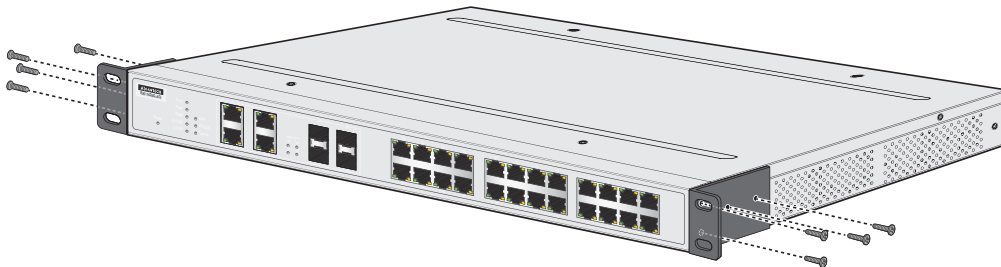

Figure 2.1 Installing the Rack Mount Brackets

3. Align the switch with the posts on the rack cabinet.
4. Secure the switch with the provided screws.

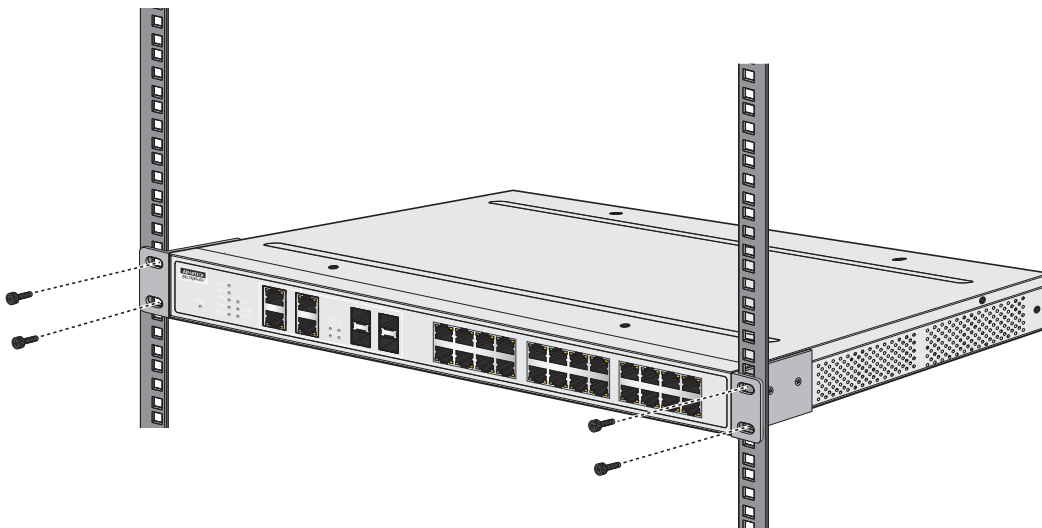

Figure 2.2 Installing the Switch

2.6 Installing and Removing SFP Modules

Up to two fiber optic ports are available (depends on model) for use in the switch. Refer to the technical specifications for details.

The Gigabit Ethernet ports on the switch are 100/1000Base SFP Fiber ports, which require using the 100M or 1G mini-GBIC fiber transceivers to work properly. Advantech provides completed transceiver models for different distance requirement.

The concept behind the LC port and cable is quite straight forward. Suppose that you are connecting devices I and II; contrary to electrical signals, optical signals do not require a circuit in order to transmit data. Consequently, one of the optical lines is used to transmit data from device I to device II, and the other optical line is used to transmit data from device II to device I, for full-duplex transmission.

Remember to connect the Tx (transmit) port of device I to the Rx (receive) port of device II, and the Rx (receive) port of device I to the Tx (transmit) port of device II. If you make your own cable, we suggest labeling the two sides of the same line with the same letter (A-to-A and B-to-B, or A1-to-A2 and B1-to-B2).

2.6.1 Installing SFP Modules

To connect the fiber transceiver and LC cable, use the following guidelines:

1. Remove the dust plug from the fiber optic slot chosen for the SFP transceiver.

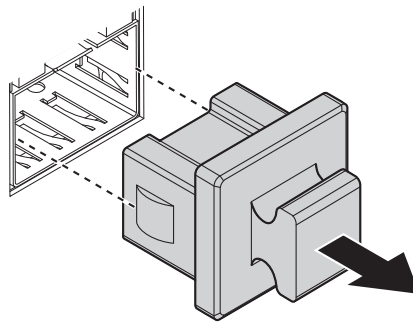

Figure 2.3 Removing the Dust Plug from an SFP Slot

Note! *Do not remove the dust plug from the SFP slot if you are not installing the transceiver at this time. The dust plug protects hardware from dust contamination.*



2. Position the SFP transceiver with the handle on top, see the following figure.
3. Locate the triangular marking in the slot and align it with the bottom of the transceiver.
4. Insert the SFP transceiver into the slot until it clicks into place.

5. Make sure the module is seated correctly before sliding the module into the slot. A click sounds when it is locked in place.

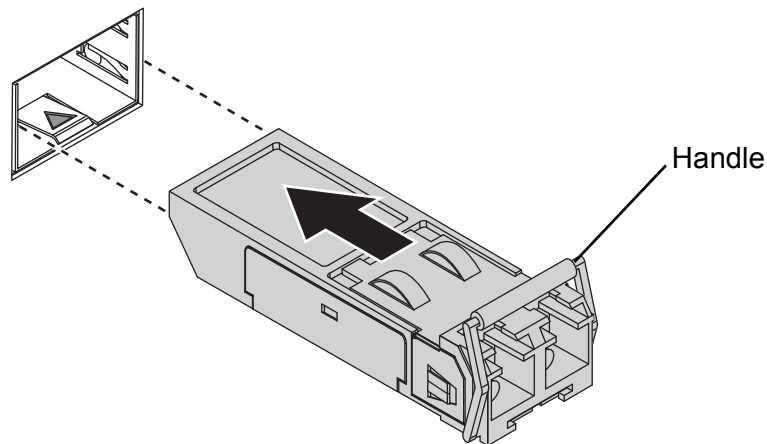

Figure 2.4 Installing an SFP Transceiver

Note! *If you are attaching fiber optic cables to the transceiver, continue with the following step. Otherwise, repeat the previous steps to install the remaining SFP transceivers in the device.*



6. Remove the protective plug from the SFP transceiver.

Note! *Do not remove the dust plug from the transceiver if you are not installing the fiber optic cable at this time. The dust plug protects hardware from dust contamination.*



7. Insert the fiber cable into the transceiver. The connector snaps into place and locks.

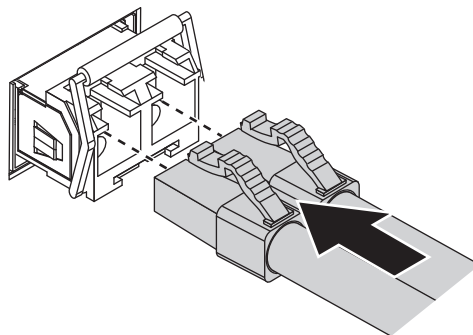

Figure 2.5 Attaching a Fiber Optic Cable to a Transceiver

8. Repeat the previous procedures to install any additional SFP transceivers in the switch.
The fiber port is now setup.

2.6.2 Removing SFP Modules

To disconnect an LC connector, use the following guidelines:

1. Press down and hold the locking clips on the upper side of the optic cable.
2. Pull the optic cable out to release it from the transceiver.

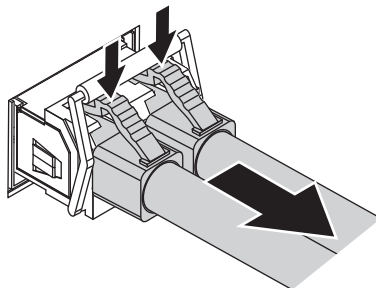

Figure 2.6 Removing a Fiber Optic Cable to a Transceiver

3. Hold the handle on the transceiver and pull the transceiver out of the slot.

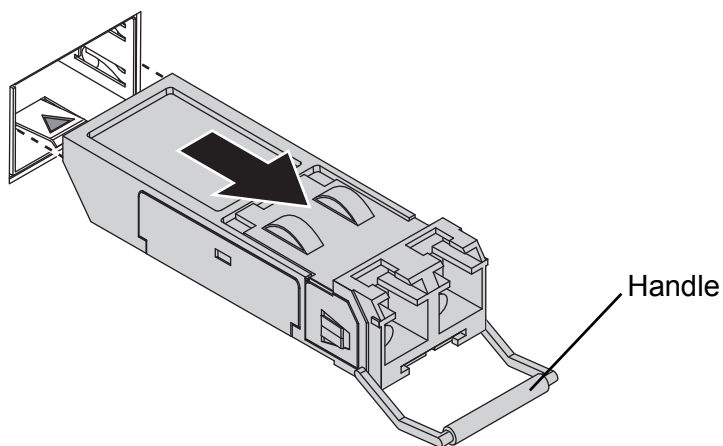

Figure 2.7 Removing an SFP Transceiver

Note! Replace the dust plug on the slot if you are not installing a transceiver. The dust plug protects hardware from dust contamination.



2.7 Connecting the Switch to Ethernet Ports

2.7.1 RJ45 Ethernet Cable Wiring

For RJ45 connectors, data-quality, twisted pair cabling (rated CAT5 or better) is recommended. The connector bodies on the RJ45 Ethernet ports are metallic and connected to the GND terminal. For best performance, use shielded cabling. Shielded cabling may be used to provide further protection.

Straight-thru Cable Wiring		Cross-over Cable Wiring	
Pin 1	Pin 1	Pin 1	Pin 3
Pin 2	Pin 2	Pin 2	Pin 6
Pin 3	Pin 3	Pin 3	Pin 1
Pin 6	Pin 6	Pin 6	Pin 2

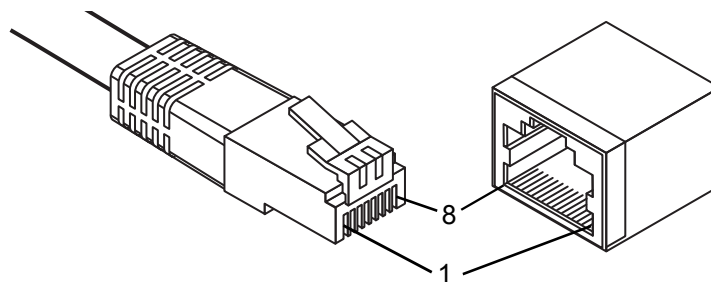

Figure 2.8 Ethernet Plug & Connector Pin Position

Maximum cable length: 100 meters (328 ft.) for 10/100/1000BaseT.

2.8 Connecting the Switch to Console Port

The industrial switch supports a secondary means of management. By connecting the RJ45 to RS232 serial cable between a COM port on your PC (9-pin D-sub female) and the switch's RJ45 (RJ45) port, a wired connection for management can be established.

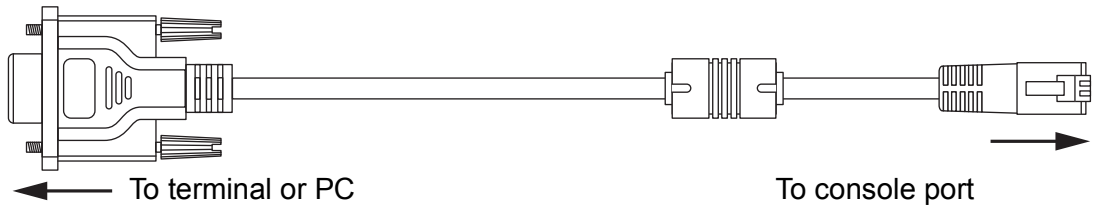

Figure 2.9 Serial Console Cable

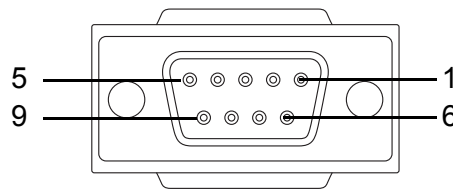

Figure 2.10 DB 9 Pin Position

DB9 Connector	RJ45 Connector
NC	1 Orange/White
NC	2 Orange
2	3 Green/White
NC	4 Blue
5	5 Blue/White
3	6 Green
NC	7 Brown/White
NC	8 Brown

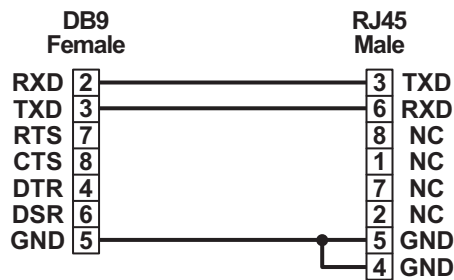

Figure 2.11 Pin Assignment

2.9 Power Supply Installation

2.9.1 Overview

Warning! Power down and disconnect the power cord before servicing or wiring the switch.



Caution! Do not disconnect modules or cabling unless the power is first switched off.



The device only supports the voltage outlined in the type plate. Do not use any other power components except those specifically designated for the switch device.

Caution! Disconnect the power cord before installation or cable wiring.



The switches can be powered by using the same DC source used to power other devices. A DC voltage range of 12 to 48 VDC (Non PoE) or 48 VDC (PoE) must be applied between the V1+ terminal and the V1- terminal (PW1), see the following illustrations. A Class 2 power supply is required to maintain a UL60950 panel listing. The chassis ground screw terminal should be tied to the panel or chassis ground. A redundant power configuration is supported through a secondary power supply unit to reduce network down time as a result of power loss.

Dual power inputs are supported and allow you to connect a backup power source.

Single DC Power

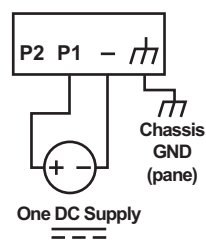

Redundant DC Power

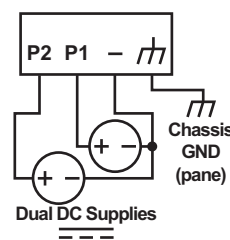

Figure 2.12 Power Wiring for EKI-7428 Series

2.9.2 Considerations

Take into consideration the following guidelines before wiring the device:

- The Terminal Block (CN1) is suitable for 12-24 AWG (3.31 - 0.205 mm²). Torque value 7 lb-in.
- The cross sectional area of the earthing conductors shall be at least 3.31 mm².
- Calculate the maximum possible current for each power and common wire. Make sure the power draw is within limits of local electrical code regulations.
- For best practices, route wiring for power and devices on separate paths.
- Do not bundle together wiring with similar electrical characteristics.
- Make sure to separate input and output wiring.
- Label all wiring and cabling to the various devices for more effective management and servicing.

Note! *Routing communications and power wiring through the same conduit may cause signal interference. To avoid interference and signal degradation, route power and communications wires through separate conduits.*



2.9.3 Grounding the Device

Caution! *Do not disconnect modules or cabling unless the power is first switched off.*



The device only supports the voltage outlined in the type plate. Do not use any other power components except those specifically designated for the switch device.

Caution! *Before connecting the device properly ground the device. Lack of a proper grounding setup may result in a safety risk and could be hazardous.*



Caution! *Do not service equipment or cables during periods of lightning activity.*



Caution! *Do not service any components unless qualified and authorized to do so.*



Caution! *Do not block air ventilation holes.*



Electromagnetic Interference (EMI) affects the transmission performance of a device. By properly grounding the device to earth ground through a drain wire, you can setup the best possible noise immunity and emissions.

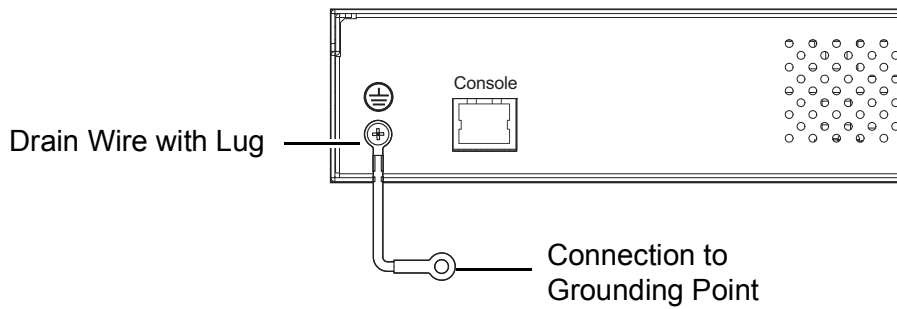

Figure 2.13 Grounding Connection

By connecting the ground terminal by drain wire to earth ground the switch and chassis can be ground.

Note! *Before applying power to the grounded switch, it is advisable to use a volt meter to ensure there is no voltage difference between the power supply's negative output terminal and the grounding point on the switch.*



2.9.4 Wiring a Relay Contact

The following section details the wiring of the relay output. The terminal block on the EKI-7428 Series is wired and then installed onto the terminal receptor located on the EKI-7428 Series.

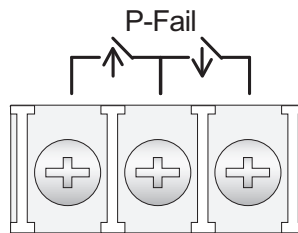

Figure 2.14 Terminal Receptor: Relay Contact

The terminal receptor includes a total of six pins: two for PWR1, two for PWR2 and two for a fault circuit.

2.9.5 Wiring the Power Inputs

Caution! Do not disconnect modules or cabling unless the power is first switched off.



The device only supports the voltage outlined in the type plate. Do not use any other power components except those specifically designated for the switch device. The temperature rating of the Input Connection Cable must be higher than 90° C.

Warning! Power down and disconnect the power cord before servicing or wiring the switch.



There are two power inputs for normal and redundant power configurations. The power input 2 is used for wiring a redundant power configuration. See the following for terminal block connector views.

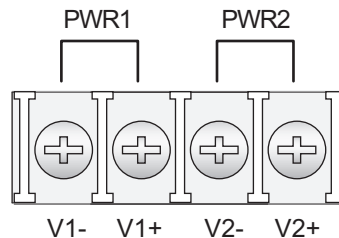

Figure 2.15 Terminal Receptor: Power Input Contacts

To wire the power inputs:

Make sure the power is not connected to the switch or the power converter before proceeding.

1. Insert a small flat-bladed screwdriver in the V1+/V1- wire-clamp screws, and loosen the screws.
2. Insert the negative/positive DC wires into the V+/V- terminals of PW1. If setting up power redundancy, connect PW2 in the same manner.
3. Tighten the wire-clamp screws to secure the DC wires in place.

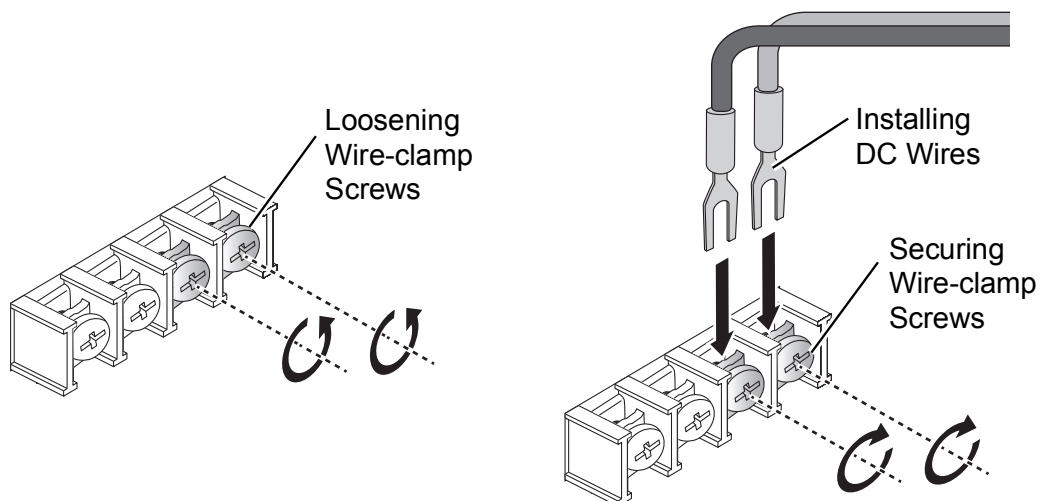

Figure 2.16 Installing DC Wires in a Terminal Block

2.10 Reset Button

Reset configuration to factory default:

Press and hold Reset button for 5 seconds.

System reboot:

Press and hold Reset button for 3 seconds.

Note! Do NOT power off the Ethernet switch when loading default settings.



Chapter 3

Configuration Utility

3.1 First Time Setup

3.1.1 Overview

The Industrial Ethernet Managed Switch is a configurable device that facilitates the interconnection of Ethernet devices on an Ethernet network. This includes computers, operator interfaces, I/O, controllers, RTUs, PLCs, other switches/hubs or any device that supports the standard IEEE 802.3 protocol.

This switch has all the capabilities of a store and forward Ethernet switch plus advanced management features such as SNMP, RSTP and port mirroring. This manual details how to configure the various management parameters in this easy to use switch.

3.1.2 Introduction

To take full advantage of all the features and resources available from the switch, it must be configured for your network.

The switch implements Rapid Spanning Tree Protocol (RSTP) and Simple Network Management Protocol (SNMP) to provide most of the services offered by the switch. Rapid Spanning Tree Protocol allows managed switches to communicate with each other to ensure that there exists only one active route between each pair of network nodes and provides automatic failover to the next available redundant route. A brief explanation of how RSTP works is given in the Spanning Tree section.

The switch is capable of communicating with other SNMP capable devices on the network to exchange management information. This statistical/derived information from the network is saved in the Management Information Base (MIB) of the switch. The MIB is divided into several different information storage groups. These groups will be elaborated in detail in the Management and SNMP information section of this document. The switch implements Internet Group Management Protocol (IGMP) to optimize the flow of multicast traffic on your network.

The switch supports both port-based and tag-based Virtual LANs for flexible integration with VLAN-aware networks with support for VLAN-unaware devices.

3.1.3 Administrative Interface Access

There are several administrative interfaces to the switch:

1. A graphical web interface accessible via the switch's built-in web server. Both HTTP and secure HTTPS with SSL are supported.

Note! *This is the recommended method for managing the switch.*



2. A terminal interface via the RS232/USB port or over the network using telnet or Secure Shell (SSH).
3. An SNMP interface can be used to read/write many settings.
4. Command Line Interface (CLI) can be used to read/write most settings. Initial setup must be done using an Ethernet connection (recommended) or the serial port.

3.1.4 Using the Graphical (Web) Interface

The graphical interface is provided via a web server in the switch and can be accessed via a web browser such as Chrome, Firefox, or Internet Explorer.

Note! *JavaScript must be supported and enabled in your browser for the graphical interface to work correctly.*



HTTP and HTTPS (secure HTTP) are supported for access to the web server. By default, only HTTP is enabled. Either or both may be enabled or disabled to secure the switch. (See the Remote Access Security topic in this section.)

To access the graphical interface, enter a URL like HTTP://192.168.1.1 in your browser's address bar. Replace "http" with "https" to use secure http and replace "192.168.1.1" with your switch's IP address if you've changed it from the factory default.

The web server in the switch uses a signed security certificate. When you access the server via https, you may see a warning dialog indicating that the certificate was signed by an unknown authority. This is expected and to avoid this message in the future you can choose to install the certificate on your computer

Note! *This manual describes and depicts the web user interface in detail. The terminal interface is not specifically shown but is basically the same.*



3.1.5 Configuring the Switch for Network Access

To control and monitor the switch via the network, it must be configured with basic network settings, including an IP address and subnet mask.

To configure the switch for network access, select [Add Menu Address Here] to reach the System Settings menu. The settings in this menu control the switch's general network configuration.

- DHCP Enabled/Disabled: The switch can automatically obtain an IP address from a server using the Dynamic Host Configuration Protocol (DHCP). This can speed up initial set up, as the network administrator does not have to find an open IP address.
- IP Address and subnet mask configuration: The IP address for the switch can be changed to a user-defined address along with a customized subnet mask to separate subnets.

Note! *Advanced users can set the IP address to 0.0.0.0 to disable the use of an IP address for additional security. However, any features requiring an IP address (i.e., web interface, etc.) will no longer be available.*



- Default Gateway Selection: A Gateway Address is chosen to be the address of a router that connects two different networks. This can be an IP address or a Fully Qualified Domain Name (FQDN) such as "domainname.org".
- NTP Server: The IP address or domain name of an NTP (Network Time Protocol) server from which the switch may retrieve the current time at startup. Please note that using a domain name requires that at least one domain name server be configured.

3.1.6 Configuring the Ethernet Ports

The switch comes with default port settings that should allow you to connect to the Ethernet Ports with out any necessary configuration. Should there be a need to change the name of the ports, negotiation settings or flow control settings, you can do this in the Port Configuration menu. Access this menu by selecting Setup from the Main menu, and then selecting Main Settings.

- **Port Name:** Each port in the managed switch can be identified with a custom name. Specify a name for each port here.
- **Admin:** Ports can be enabled or disabled in the managed switch. For ports that are disabled, they are virtually non-existent (not visible in terms of switch operation or spanning tree algorithm). Choose to enable or disable a port by selecting Enabled or Disabled, respectively.
- **Negotiation:** All copper ports and gigabit fiber ports in the managed switch are capable of autonegotiation such that the fastest bandwidth is selected. Choose to enable auto-negotiation or use fixed settings. 100Mbps Fiber ports are Fixed speed only.
- **Speed/Duplex/Flow Control:** The managed switch accepts three local area network Ethernet Standards. The first standard, 10BASE-T, runs 10Mbps with twisted pair Ethernet cable between network interfaces. The second local area network standard is 100BASE-T, which runs at 100Mbps over the same twisted pair Ethernet cable. Lastly, there is 100BASE-F, which enables fast Ethernet (100Mbps) over fiber.

These options are available:

- 10h–10 Mbps, Half Duplex
- 10f –10 Mbps, Full Duplex
- 100h–100 Mbps, Half Duplex
- 100f –100 Mbps, Full Duplex
- 1000f–1000 Mbps, Full Duplex

On managed switches with gigabit combination ports, those ports with have two rows, a standard row of check boxes and a row labeled “SFP” with radio buttons. The SFP setting independently sets the speed at which a transceiver will operate if one is plugged in. Otherwise, the switch will use the fixed Ethernet port and the corresponding settings for it

Note! *When 100f is selected for the SFP of a gigabit combination port, the corresponding fixed Ethernet jack will be disabled unless it is changed back to 1000F.*



3.2 Command Line Interface Configuration

3.2.1 Introduction to Command-Line Interface (CLI)

The command-line interface (CLI) is constructed with an eye toward automation of CLI-based configuration. The interaction is modeled on that used in many Internet protocols such as Telnet, FTP, and SMTP. After each command is entered and processed, the switch will issue a reply that consists of a numeric status code and a human-readable explanation of the status.

The general format of commands is:

```
section parameter [value]
```

where:

- section is used to group parameters.
- parameter will specify the parameter within the section. For example, the network section will have parameters for DHCP, IP address, subnet mask, and default gateway.
- value is the new value of the parameter. If value is omitted, the current value is displayed.

Please note that new values will not take effect until explicitly committed.

Sections and parameter names are case sensitive (e.g., “Network” is not the same as “network”)

Note! *Any commands in the CLI Commands section of this chapter, with the exception of the global commands, must be prefaced with the name of the section they are in. For example, to change the IP address of the switch, you would type:*



```
network address <newIP>
```

3.2.2 Accessing the CLI

To access the CLI interface, establish Ethernet or serial connectivity to the switch.

To connect by Ethernet, open a command prompt window and type:

```
telnet <switchip> (where <switchip> is the IP address of the switch)
```

At the login prompt, type “cli” for the username and “admin” for the password. The switch will respond with “Managed switch configuration CLI ready”.

3.3 Web Browser Configuration

The switch has an HTML based user interface embedded in the flash memory. The interface offers an easy to use means to manage basic and advanced switch functions. The interface allows for local or remote switch configuration anywhere on the network.

The interface is designed for use with [Internet Explorer (6.0), Chrome, Firefox].

3.3.1 Preparing for Web Configuration

The interface requires the installation and connection of the switch to the existing network. A PC also connected to the network is required to connect to the switch and access the interface through a web browser. The required networking information is provided as follows:

- IP address: 192.168.1.1
- Subnet mask: 255.255.255.0
- Default gateway: 192.168.1.254
- User name: admin
- Password: admin

3.3.2 System Login

Once the switch is installed and connected, power on the switch. The following information guides you through the logging in process.

1. Launch your web browser on the PC.
2. In the browser's address bar, type the switch's default IP address (192.168.1.1). The login screen displays.
3. Enter the user default name and password (admin / admin).
4. Click **OK** on the login screen to log in. The main interface displays.

Chapter 4

Managing Switch

4.1 Log In

To access the login window, connect the device to the network, see “Connecting the Switch to Ethernet Ports” on page 15. Once the switch is installed and connected, power on the switch see the following procedures to log into your switch.

When the switch is first installed, the default network configuration is set to DHCP enabled. You will need to make sure your network environment supports the switch setup before connecting it to the network.

1. Launch your web browser on a computer.
2. In the browser’s address bar type in the switch’s default IP address (192.168.1.1). The login screen displays.
3. Enter the default user name and password (admin/admin) to log into the management interface. You can change the default password after you have successfully logged in.
4. Click **Login** to enter the management interface.

The image shows a login screen with a light yellow background and a blue border. It contains two text input fields: the top one is labeled "Username" and the bottom one is labeled "Password". Below the password field is a blue button with the text "Login" in white.

Figure 4.1 Login Screen

4.2 Recommended Practices

One of the easiest things to do to help increase the security posture of the network infrastructure is to implement a policy and standard for secure management. This practice is an easy way to maintain a healthy and secure network.

After you have performed the basic configurations on your switches, the following is a recommendation which is considered best practice policy.

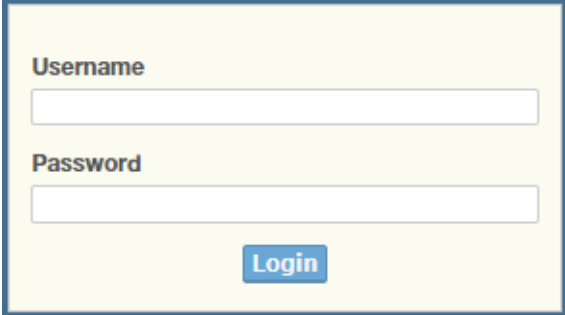
4.2.1 Changing Default Password

In keeping with good management and security practices, it is recommended that you change the default password as soon as the device is functioning and setup correctly. The following details the necessary steps to change the default password.

To change the password:

1. Navigate to **Tools > User Account**.
2. From the User drop-down menu, select the Admin (default) account.
3. In the **User Name** field, enter admin for this account. It is not necessary to change the user name, however, a change in the default settings increases the security settings.
4. In the **Password** field, type in the new password. Re-type the same password in the **Retype Password** field.

- Click **Apply** to change the current account settings.

Figure 4.2 Changing a Default Password

After saving all the desired settings, perform a system save (**Tools > Save Configuration**). The changes are saved.

4.3 Monitoring

4.3.1 Device Information

The Device Information menu lists information, such as: System Name, System Location, MAC Address, Firmware version, and more, pertaining to the system. The information is for review only. To modify the device information, see the respective item within the user interface.

To access this page, click **Monitoring > Device Information**.

Information Name	Information Value
System Name	Switch
System Location	Default
System Contact	Default
MAC Address	C4:00:AD:F2:12:C8
IP Address	192.168.1.1
Subnet Mask	255.255.255.0
Gateway	192.168.1.254
Loader Version	1.01.S05011
Loader Date	Oct 22 2020 - 16:26:44
Firmware Version	1.02.01
Firmware Date	Oct 22 2020 - 16:27:05
Build Version	D091016S05255
System OID	1.3.6.1.4.1.10297.202.7000
System Up Time	0 days, 0 hours, 14 mins, 12 secs

Figure 4.3 Monitoring > Device Information

The following table describes the items in the previous figure.

Item	Description
System Name	Click Switch to enter the system name: up to 128 alphanumeric characters (default is Switch).
System Location	Click Default to enter the location: up to 256 alphanumeric characters (default is Default).

Item	Description
System Contact	Click Default to enter the contact person: up to 128 alphanumeric characters (default is Default).
MAC Address	Displays the MAC address of the switch.
IP Address	Displays the assigned IP address of the switch.
Subnet Mask	Displays the assigned subnet mask of the switch.
Gateway	Displays the assigned gateway of the switch.
Loader Version	Displays the current loader version of the switch.
Loader Date	Displays the current loader build date of the switch.
Firmware Version	Displays the current firmware version of the switch.
Firmware Date	Displays the current firmware build date of the switch.
Build Version	Displays the current firmware build version of the switch.
System Object ID	Displays the base object ID of the switch.
System Up Time	Displays the time since the last switch reboot.

4.3.2 Logging Message

The Logging Message Filter page allows you to enable the display of logging message filter.

To access this page, click **Monitoring > Logging Message**.

Figure 4.4 Monitoring > Logging Message

The following table describes the items in the previous figure.

Item	Description
Target	Click the drop-down menu to select a target to store the log messages. <ul style="list-style-type: none"> ■ Buffered: Store log messages in RAM. All log messages are cleared after system reboot. ■ File: Store log messages in a file.
Severity	The setting allows you to designate a severity level for the Logging Message Filter function. Click the drop-down menu to select the severity level target setting. The level options are: <ul style="list-style-type: none"> ■ emerg: Indicates system is unusable. It is the highest level of severity. ■ alert: Indicates action must be taken immediately. ■ crit: Indicates critical conditions. ■ error: Indicates error conditions. ■ warning: Indicates warning conditions. ■ notice: Indicates normal but significant conditions. ■ info: Indicates informational messages. ■ debug: Indicates debug-level messages.
Category	Click the drop-down menu to select the category level target setting.

Item	Description
View	Click View to display all Logging Information and Logging Message information.
Refresh	Click Refresh to update the screen.
Clear buffered messages	Click Clear buffered messages to clear the logging buffer history list.

The ensuing table for Logging Information table settings are informational only: Target, Severity and Category.

Information Name	Information Value
Target	buffered
Severity	emerg, alert, crit, error, warning, notice
Category	ACL, CABLE_DIAG, IGMP_SNOOPING, MLD_SNOOPING, L2, LLDP, Mirror, Platform, PM, Port, QoS, Rate, SNMP, STP, LBD, GVRP, Security, System, Trunk, VLAN, QINQ, XRing, XRing3, ERPS, PoE

Figure 4.5 Monitoring > Logging Information

The ensuing table for Logging Message table settings are informational only: No, Time Stamp, Category, Severity, and Message.

No.	Time Stamp	Category	Severity	Message
1	Jan 01 2000 08:13:18	System	notice	New http connection for user admin, source 192.168.1.2 ACCEPTED
2	Jan 01 2000 08:03:41	System	notice	New http connection for user admin, source 192.168.1.2 ACCEPTED
3	Jan 01 2000 08:00:36	System	crit	System cold start
4	Jan 01 2000 08:00:36	System	notice	Logging is enabled
5	Jan 01 2000 08:00:36	System	crit	power supply 1 is powered down

Figure 4.6 Monitoring > Logging Message

4.3.3 Port Monitoring

Port Network Monitor is a bandwidth and network monitoring tool for the purpose of capturing network traffic and measuring of network throughput. The monitoring functionality includes listing of port statistics as well as port utilization.

4.3.3.1 Port Statistics

To access this page, click **Monitoring > Port Monitoring > Port Statistics**.

Port MIB Counters Settings

Port: GE1

Clear

Figure 4.7 Monitoring > Port Monitoring > Port Statistics

The following table describes the items in the previous figure.

Item	Description
Port	Click the drop-down menu to select a port and its captured statistical setting values.
Clear	Click Clear to clear the counter selections.

The following table provides information for **IF MIB Counters** settings.

GE1 IF MIB Counters	
IF MIB Counter Name	MIB Counter Value
ifInOctets	0
ifInUcastPkts	0
ifInNUcastPkts	0
ifInDiscards	0
ifOutOctets	0
ifOutUcastPkts	0
ifOutNUcastPkts	0
ifOutDiscards	0
ifInMulticastPkts	0
ifInBroadcastPkts	0
ifOutMulticastPkts	0
ifOutBroadcastPkts	0

Figure 4.8 Monitoring > Port Monitoring > IF MIB Counters

The following table provides information for **Ether-Like MIB Counters** settings.

GE1 Ether-Like MIB Counters	
Ether-Like MIB Counter Name	MIB Counter Value
dot3StatsAlignmentErrors	0
dot3StatsFCSErrors	0
dot3StatsSingleCollisionFrames	0
dot3StatsMultipleCollisionFrames	0
dot3StatsDeferredTransmissions	0
dot3StatsLateCollisions	0
dot3StatsExcessiveCollisions	0
dot3StatsFrameTooLongs	0
dot3StatsSymbolErrors	0
dot3ControlInUnknownOpcodes	0
dot3InPauseFrames	0
dot3OutPauseFrames	0

Figure 4.9 Monitoring > Port Monitoring > Ether-Like MIB Counters

The following table provides information for **RMON MIB Counters** settings.

GE1 Rmon MIB Counters	
Rmon MIB Counter Name	MIB Counter Value

Figure 4.10 Monitoring > Port Monitoring > Ether-Like MIB Counters

4.3.3.2 Port Utilization

To access this page, click **Monitoring > Port Monitoring > Port Utilization**.

Port Settings

Gbps
100Mbps
10Mbps
Refresh period
IFG

10 Secs
Enable

Figure 4.11 Monitoring > Port Monitoring > Port Utilization

The following table describes the items in the previous figure.

Item	Description
Refresh period	Click the drop-down menu to select and designate a period (second intervals) to refresh the information (TX and RX) listings.
IFG	Click the drop-down menu to enable or disable the Interframe Gap (IFG) statistic.

4.3.3.3 Port Error Disable

The Port Error Disable page displays the error information of the switch ports. To access this page, click **Monitoring > Port Monitoring > Port Error Disable**

Error Disable Reason	Timer Status	Recover Time
bpduguard	Disabled	0
storm-control	Disabled	0
ingress-bandwidth-control	Disabled	0
loopback-detection	Enabled	60

Figure 4.12 Monitoring > Port Monitoring > Port Error Disable

The following table describes the items in the previous figure.

Item	Description
bpduguard	Displays the error status.
storm-control	Displays the error status.
ingress-bandwidth-control	Displays the error status.
loopback-detection	Displays the error status.

4.3.4 Link Aggregation

The Link Aggregation function provides LAG information for each trunk. It displays membership status, link state and membership type for each port.

To access this page, click **Monitoring > Link Aggregation**.

LAG	Name	Type	Link State	Active Member	Standby Member
Trunk1		---	Not Present	-	-
Trunk2		---	Not Present	-	-
Trunk3		---	Not Present	-	-
Trunk4		---	Not Present	-	-
Trunk5		---	Not Present	-	-
Trunk6		---	Not Present	-	-
Trunk7		---	Not Present	-	-
Trunk8		---	Not Present	-	-

Figure 4.13 Monitoring > Link Aggregation

4.3.5 LLDP Statistics

The LLDP Statistics page displays the LLDP statistics.

To access this page, click **Monitoring > LLDP Statistics**.

Information Name	Information Value
Insertions	0
Deletions	0
Drops	0
Age Outs	0

Figure 4.14 Monitoring > LLDP Statistics

The following table describes the items in the previous figure.

Item	Description
Clear	Click Clear to reset LLDP Statistics of all the interfaces.
Refresh	Click Refresh to update the data on the screen with the present state of the data in the switch.

The following figure displays the **LLDP Port Statistics** settings.

Port	TX Frames	RX Frames			RX TLVs		RX Ageouts
	Total	Total	Discarded	Errors	Discarded	Unrecognized	Total
GE1	0	0	0	0	0	0	0
GE2	0	0	0	0	0	0	0
GE3	0	0	0	0	0	0	0
GE4	0	0	0	0	0	0	0
GE5	0	0	0	0	0	0	0
GE6	0	0	0	0	0	0	0
GE7	0	0	0	0	0	0	0
GE8	0	0	0	0	0	0	0
GE9	0	0	0	0	0	0	0
GE10	0	0	0	0	0	0	0
GE11	0	0	0	0	0	0	0

Figure 4.15 Monitoring > LLDP Port Statistics

4.3.6 IGMP Statistics

The IGMP Statistics function displays statistical package information for IP multi casting.

To access this page, click **Monitoring > IGMP Statistics**.

Clear Refresh	
IGMP Statistics	
Statistics Packets	Counter
Total RX	0
Valid RX	0
Invalid RX	0
Other RX	0
Leave RX	0
Report RX	0
General Query RX	0
Special Group Query RX	0
Special Group & Source Query RX	0
Leave TX	0
Report TX	0
General Query TX	0
Special Group Query TX	0
Special Group & Source Query TX	0

Figure 4.16 Monitoring > IGMP Statistics

The following table describes the items in the previous figure.

Item	Description
Clear	Click Clear to refresh IGMP Statistics of all the interfaces.
Refresh	Click Refresh to update the data on the screen with the present state of the data in the switch.

The ensuing table for **IGMP Statistics** settings are informational only: Total RX, Valid RX, Invalid RX, Other RX, Leave RX, Report RX, General Query RX, Special Group Query RX, Special Group & Source Query RX, Leave TX, Report TX, General Query TX, Special Group Query TX and Special Group & Source Query TX.

4.3.7 MLD Statistics

The MLD Statistics function displays statistical package information for MLD message.

To access this page, click **Monitoring > MLD Statistics**.

MLD Statistics	
Statistics Packets	Counter
Total RX	0
Valid RX	0
Invalid RX	0
Other RX	0
Leave RX	0
Report RX	0
General Query RX	0
Special Group Query RX	0
Special Group & Source Query RX	0
Leave TX	0
Report TX	0
General Query TX	0
Special Group Query TX	0
Special Group & Source Query TX	0

Figure 4.17 Monitoring > MLD Statistics

The following table describes the items in the previous figure.

Item	Description
Clear	Click Clear to refresh MLD Statistics of all the interfaces.
Refresh	Click Refresh to update the data on the screen with the present state of the data in the switch.

The ensuing table for **IGMP Statistics** settings are informational only: Total RX, Valid RX, Invalid RX, Other RX, Leave RX, Report RX, General Query RX, Special Group Query RX, Special Group & Source Query RX, Leave TX, Report TX, General Query TX, Special Group Query TX and Special Group & Source Query TX.

4.4 System

4.4.1 IP Settings

The IP Settings menu allows you to select a static or DHCP network configuration. The Static displays the configurable settings for the static option.

To access this page, click **System > IP Settings**.

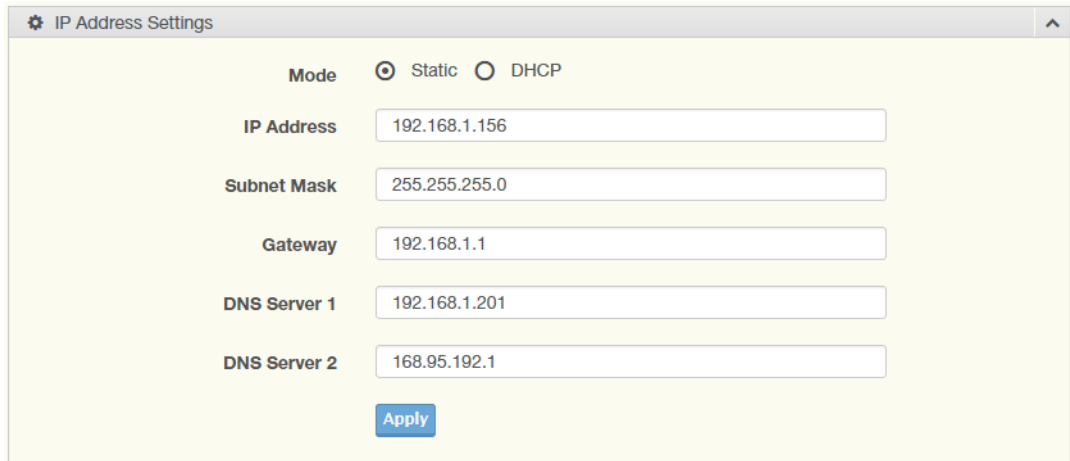
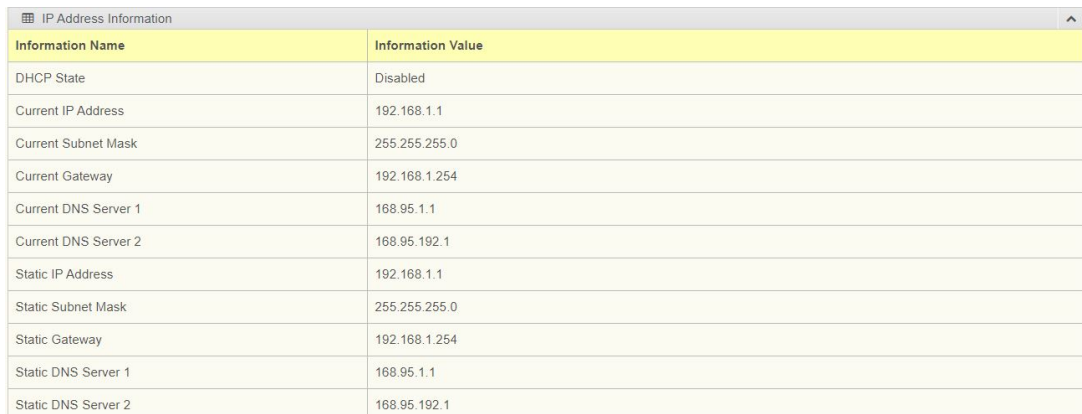

Figure 4.18 System > IP Settings

The following table describes the items in the previous figure.

Item	Description
Mode	Click the radio button to select the IP Address Setting mode: Static or DHCP.
IP Address	Enter a value to specify the IP address of the interface. The default is 192.168.1.1.
Subnet Mask	Enter a value to specify the IP subnet mask for the interface. The default is 255.255.255.0.
Gateway	Enter a value to specify the default gateway for the interface. The default is 192.168.1.254.
DNS Server 1	Enter a value to specify the DNS server 1 for the interface. The default is 168.95.1.1.
DNS Server 2	Enter a value to specify the DNS server 2 for the interface. The default is 168.95.192.1.
Apply	Click Apply to save the values and update the screen.

The following figure displays the **IP Address Information** settings



Information Name	Information Value
DHCP State	Disabled
Current IP Address	192.168.1.1
Current Subnet Mask	255.255.255.0
Current Gateway	192.168.1.254
Current DNS Server 1	168.95.1.1
Current DNS Server 2	168.95.192.1
Static IP Address	192.168.1.1
Static Subnet Mask	255.255.255.0
Static Gateway	192.168.1.254
Static DNS Server 1	168.95.1.1
Static DNS Server 2	168.95.192.1

Figure 4.19 System > IP Address Information

4.4.2 IPv6 Settings

To access this page, click **System > IPv6 Settings**.

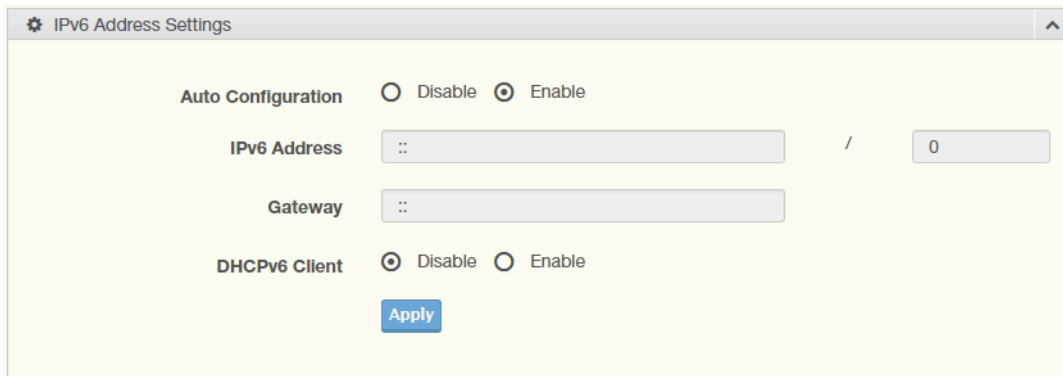

Figure 4.20 System > IPv6 Settings

The following table describes the items in the previous figure.

Item	Description
Auto Configuration	Select the radio button to enable or disable the IPv6.
IPv6 Address	Enter the IPv6 address for the system.
Gateway	Enter the gateway address for the system.
DHCPv6 Client	Enter the DHCPv6 address for the system.
Apply	Click Apply to save the values and update the screen.

The ensuing table for **IPv6 Information** settings are informational only: Auto Configuration, IPv6 In Use Address, IPv6 In Use Router, IPv6 Static Address, IPv6 Static Router and DHCPv6 Client.

The following figure displays the **IPv6 Information** settings

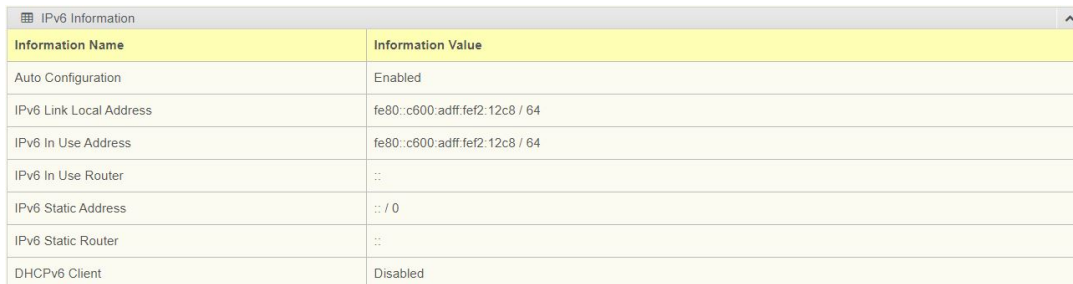

Information Name	Information Value
Auto Configuration	Enabled
IPv6 Link Local Address	fe80::c600:adff:fe2:12c8 / 64
IPv6 In Use Address	fe80::c600:adff:fe2:12c8 / 64
IPv6 In Use Router	::
IPv6 Static Address	:: / 0
IPv6 Static Router	::
DHCPv6 Client	Disabled

Figure 4.21 System > IPv6 Information

4.4.3 DHCP Client Option 82

The DHCP Client Option 82 configurable Circuit ID and Remote ID feature enhances validation security by allowing you to select naming choices suboptions. You can select a switch-configured hostname or specify an ASCII test string for the remote ID. You can also configure an ASCII text string to override the circuit ID.

To access this page, click **System > DHCP Client Option 82**.

Figure 4.22 System > DHCP Client Option 82

The following table describes the items in the previous figure.

Item	Description
Mode	Click the radio button to enable or disable the DHCP Client Option 82 mode.
Circuit ID Format	Click the drop-down menu to set the ID format: String, Hex, User Definition.
Circuit ID String	Enter the string ID of the corresponding class.
Circuit ID Hex	Enter the hex string of the corresponding class.
Circuit ID User-Define	Enter the user definition of the corresponding class.
Remote ID Format	Click the drop-down menu to set the Remote ID format: String, Hex, User Definition.
Remote ID String	Enter the remote string ID of the corresponding class.
Remote ID Hex	Enter the remote hex string of the corresponding class.
Remote ID User-Define	Enter the remote user definition of the corresponding class.
Apply	Click Apply to save the values and update the screen.

The ensuing table for **DHCP Client Option 82 Information** table settings are informational only: Status, Circuit ID Format, Circuit ID String, Circuit ID Hex, Circuit ID User-Define, Remote ID Format, Remote ID String, Remote ID Hex and Remote ID User-Define.

The following figure displays the **DHCP Client Option 82 Information** settings

Information Name	Information Value
Status	Disabled
Circuit ID Format	String
Circuit ID String	<input type="text"/>
Circuit ID Hex	<input type="text"/>
Circuit ID User-Define	<input type="text"/>
Remote ID Format	String
Remote ID String	<input type="text"/>
Remote ID Hex	<input type="text"/>
Remote ID User-Define	<input type="text"/>

Figure 4.23 System > DHCP Client Option 82 Information

4.4.4 DHCP Auto Provision

The DHCP Auto Provision feature allows you to load configurations using a server with DHCP options. Through the remote connection, the switch obtains information from a configuration file available through the TFTP server.

To access this page, click **System > DHCP Auto Provision**.

Information Name	Information Value
Status	Disabled

Figure 4.24 System > DHCP Auto Provision

The following table describes the items in the previous figure.

Item	Description
Status	Select the radio button to enable or disable the DHCP Auto Provisioning Setting.
Apply	Click Apply to save the values and update the screen.

The following figure displays the **DHCP Auto Provision Information** settings

Information Name	Information Value
Status	Disabled
Circuit ID Format	String
Circuit ID String	<input type="text"/>
Circuit ID Hex	<input type="text"/>
Circuit ID User-Define	<input type="text"/>
Remote ID Format	String
Remote ID String	<input type="text"/>
Remote ID Hex	<input type="text"/>
Remote ID User-Define	<input type="text"/>

Figure 4.25 System > DHCP Auto Provision Information

4.4.5 Management VLAN

By default the VLAN is the management VLAN providing communication with the switch management interface.

To access this page, click **System > Management VLAN**.

Figure 4.26 System > Management VLAN

The following table describes the items in the previous figure.

Item	Description
Management VLAN	Click the drop-down menu to select a defined VLAN.
Apply	Click Apply to save the values and update the screen.

The ensuing table for **Management VLAN State** are informational only: Management VLAN.

4.4.6 System Time

To access this page, click **System > System Time**.

Figure 4.27 System > System Time

The following table describes the items in the previous figure.

Item	Description
Enable SNTP	Click the radio button to enable or disable the SNTP.

Item	Description
SNTP/NTP Server Address	Enter the address of the SNTP server. This is a text string of up to 64 characters containing the encoded unicast IP address or hostname of a SNTP server. Unicast SNTP requests will be sent to this address. If this address is a DNS hostname, then that hostname should be resolved into an IP address each time a SNTP request is sent to it.
SNTP Port	Enter the port on the server to which SNTP requests are to be sent. Allowed range is 1 to 65535 (default: 123).
Manual Time	Click the drop-down menus to set local date and time of the system.
Time Zone	Click the drop-down menu to select a system time zone.
Daylight Saving Time	Click the drop-down menu to enable or disable the daylight saving time settings.
Daylight Saving Time Offset	Enter the offsetting variable in seconds to adjust for daylight saving time.
Recurring From	Click the drop-down menu to designate the start date and time for daylight saving time.
Recurring To	Click the drop-down menu to designate the end date and time for daylight saving time.
Non-Recurring From	Click the drop-down menu to designate a start date and time for a non-recurring daylight saving time event.
Non-Recurring To	Click the drop-down menu to designate the end date and time for a non-recurring daylight saving time event.
Apply	Click Apply to save the values and update the screen.

The following figure displays the **System Time Information** settings

Information Name	Information Value
Current Date/Time	05:15:01 DFL(GMT+8) Jan 02 2000
SNTP	Disabled
SNTP Server Address	
SNTP Server Port	123
Time zone	GMT+8
Daylight Saving Time	Disabled
Daylight Saving Time Offset	
From	
To	

Figure 4.28 System > System Time Information

4.4.7 Network Port

To access this page, click **System > Network Port**.

Network Port Settings

HTTP: 80

HTTPS: 443

TELNET: 23

SSH: 22

Apply

Figure 4.29 System > Network Port

The following table describes the items in the previous figure.

Item	Description
HTTP	By default, the HTTPS port setting is set to port 80. To assign the web interface to a different port, enter the port number in the field.
HTTPS	By default, the HTTPS port setting is set to port 443. To assign the web interface to a different port, enter the port number in the field.
TELNET	By default, the TELNET port setting is set to port 23. To assign the web interface to a different port, enter the port number in the field.
SSH	By default, the SSH port setting is set to port 22. To assign the web interface to a different port, enter the port number in the field.
Apply	Click Apply to save the values and update the screen.

The ensuing table for **Network Port Information** are informational only: HTTP, HTTPS, TELNET and SSH.

4.5 L2 Switching

4.5.1 Port Configuration

Port Configuration describes how to use the user interface to configure LAN ports on the switch.

To access this page, click **L2 Switching > Port Configuration**.

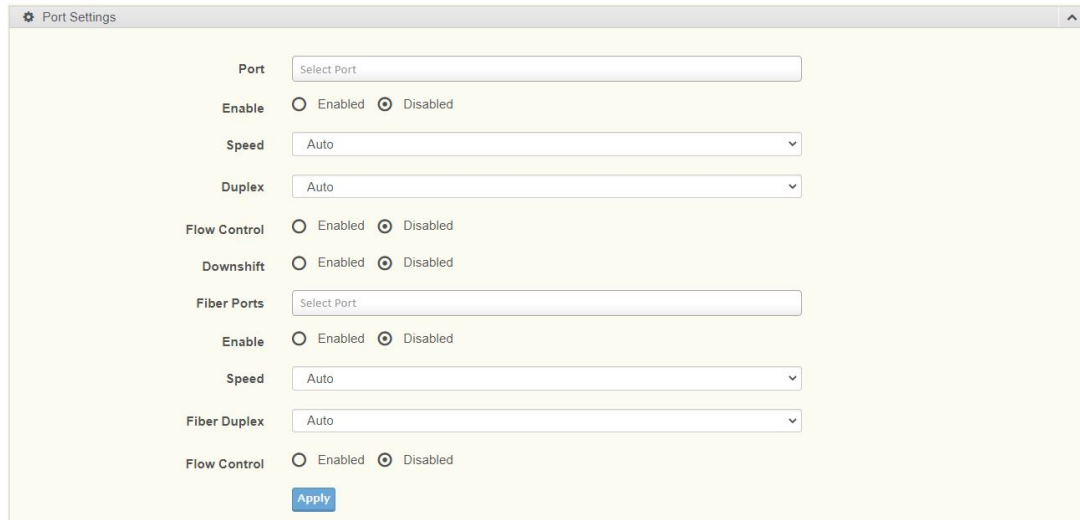

Figure 4.30 L2 Switching > Port Configuration

The following table describes the items in the previous figure.

Item	Description
Port	Click the drop-down menu to select the port for the L2 Switch setting.
Enabled	Click the radio-button to enable or disable the Port Setting function.
Speed	Click the drop-down menu to select the port speed: Auto, Auto-10M, Auto-100M, Auto-1000M, Auto-10/100M, 10M, 100M, or 1000M.
Duplex	Click the drop-down menu to select the duplex setting: Auto, Half or Full.
Flow Control	Click the radio button to enable or disable the flow control function.
Downshift	Click the radio button to enable or disable the downshift function for speed.
Fiber Port	Click the drop-down menu to select the port for the L2 Switch Fiber port setting.
Enabled	Click the radio-button to enable or disable the Fiber Port Setting function.
Speed	Click the drop-down menu to select the fiber port speed: Auto, Auto-1000M, 100M, or 1000M.
Duplex	Click the drop-down menu to select the duplex setting: Half or Full.
Flow Control	Click the radio button to enable or disable the flow control function.
Apply	Click Apply to save the values and update the screen.

The following figure shows the **Port Name Settings** with Display Method.



Figure 4.31 L2 Switching > Port Name Settings

The following figure displays the **Port Status** settings.

Port	Description	Enable State	Link Status	Speed	Duplex	DownShift	FlowCtrl Config	FlowCtrl Status
GE1	Edit	Enabled	DOWN	Auto	Auto	Enabled	Disabled	Disabled
GE2	Edit	Enabled	DOWN	Auto	Auto	Enabled	Disabled	Disabled
GE3	Edit	Enabled	DOWN	Auto	Auto	Enabled	Disabled	Disabled
GE4	Edit	Enabled	DOWN	Auto	Auto	Enabled	Disabled	Disabled
GE5	Edit	Enabled	DOWN	Auto	Auto	Enabled	Disabled	Disabled
GE6	Edit	Enabled	DOWN	Auto	Auto	Enabled	Disabled	Disabled
GE7	Edit	Enabled	DOWN	Auto	Auto	Enabled	Disabled	Disabled

Figure 4.32 L2 Switching > Port Status

4.5.2 Port Mirror

Port mirroring function allows the sending of a copy of network packets seen on one switch port to a network monitoring connection on another switch port. Port mirroring can be used to analyze and debug data or diagnose errors on a network or to mirror either inbound or outbound traffic (or both).

There are no preset values in the Port Mirror. The displayed values do not represent the actual setting values.

To access this page, click **L2 Switching > Port Mirror**.

Figure 4.33 L2 Switching > Port Mirror

The following table describes the items in the previous figure.

Item	Description
Session ID	Click the drop-down menu to select a port mirroring session from the list. The number of sessions allowed is platform specific.
Monitor session state	Click the drop-down menu to enable or disable the session mode for a selected session ID.
Destination Port	Click the drop-down menu to select the destination port and receive all the traffic from configured mirrored port(s).
Allow-ingress	Click the drop-down menu to enable or disable the Allow-ingress function.

Item	Description
Sniffer RX Ports	Enter the variable to define the RX port.
Sniffer TX Ports	Enter the variable to define the TX port.
Apply	Click Apply to save the values and update the screen.

RSPAN Settings allow you to analyze network traffic passing through VLANs or ports by using the RSPAN function to direct a copy of the traffic to a corresponding port.

The following figure displays the **RSPAN** settings.

Figure 4.34 L2 Switching > RSPAN

Item	Description
Session ID	Enter the session ID for RSPAN
Rspan VLAN	Enter the value to the corresponding RSPAN VLAN ID
Rspan tag action	Click to add, remove, and no-modify the entry.
Apply	Click Apply to save the values and update the screen.

The following figure displays the **Mirror Status** settings.

Session ID	Destination Port	Ingress State	Source TX Port	Source RX Port	Rspan VLAN	Rspan Tag Action
1	N/A	N/A	N/A	N/A	N/A	N/A
2	N/A	N/A	N/A	N/A	N/A	N/A
3	N/A	N/A	N/A	N/A	N/A	N/A
4	N/A	N/A	N/A	N/A	N/A	N/A

Figure 4.35 L2 Switching > Mirror Status

4.5.3 Link Aggregation

Link Aggregation is a method for combining multiple network connections in parallel in order to increase throughput beyond the capability of a single connection, and to provide redundancy in case one of the links should fail.

4.5.3.1 Load Balance

The Load Balancing page allows you to select between a MAC Address or IP/MAC Address algorithm for the even distribution of IP traffic across two or more links.

To access this page, click **L2 Switching > Link Aggregation > Load Balance**.

Figure 4.36 L2 Switching > Link Aggregation > Load Balance

The following table describes the items in the previous figure.

Item	Description
Load Balance Algorithm	Select the radio button to select the Load Balance Setting: MAC Address, IP/MAC Address or Source Port.
Apply	Click Apply to save the values and update the screen.

The following figure displays the **Load Balance Information** settings.

Information Name	Information Value
Load Balance Algorithm	src-dst-mac

Figure 4.37 L2 Switching > Link Aggregation > Load Balance Information

4.5.3.2 LAG Management

Link aggregation is also known as trunking. It is a feature available on the Ethernet gateway and is used with Layer 2 Bridging. Link aggregation allows for the logical merging of multiple ports into a single link.

To access this page, click **L2 Switching > Link Aggregation > LAG Management**.

Figure 4.38 L2 Switching > Link Aggregation > LAG Management

The following table describes the items in the previous figure.

Item	Description
LAG	Click the drop-down menu to select the designated trunk group: Trunk 1 ~8.
Name	Enter an entry to specify the LAG name.
Type	Click the radio button to specify the type mode: Static or LACP.
Ports	Click the drop-down menu to select designated ports: FE1-8 or GE1-2.
Apply	Click Apply to save the values and update the screen.

The following figure displays the **LAG Management Information** settings.

LAG	Name	Type	Link State	Active Member	Standby Member	Modify
Trunk1		---	Not Present	-	-	Edit Clear
Trunk2		---	Not Present	-	-	Edit Clear
Trunk3		---	Not Present	-	-	Edit Clear
Trunk4		---	Not Present	-	-	Edit Clear
Trunk5		---	Not Present	-	-	Edit Clear
Trunk6		---	Not Present	-	-	Edit Clear
Trunk7		---	Not Present	-	-	Edit Clear
Trunk8		---	Not Present	-	-	Edit Clear

Figure 4.39 L2 Switching > Link Aggregation > LAG Management Information

4.5.3.3 LAG Port Settings

The LAG Port Settings page allows you to enable or disable, set LAG status, speed and flow control functions.

In this example we will configure a LAG between the following switches:

To access this page, click **L2 Switching > Link Aggregation > LAG Port Settings**.

Figure 4.40 L2 Switching > Link Aggregation > LAG Port Settings

The following table describes the items in the previous figure.

Item	Description
LAG Select	Click the drop-down menu to select a predefined LAG trunk definition: LAG 1-8.
Enabled	Click the radio button to enable or disable the LAG Port.
Speed	Click the drop-down menu to select the port speed: Auto, Auto-10M, Auto-100M, Auto-1000M, Auto-10/100M, 10M, 100M, or 1000M.
Flow Control	Click the radio button to enable or disable the Flow Control for the LAG Port.
Apply	Click Apply to save the values and update the screen.

The following figure displays the **LAG Port Status** settings

LAG	Description	Port Type	Enable State	Link Status	Speed	Duplex	FlowCtrl Config	FlowCtrl Status
Trunk1			Enabled		Auto	Auto	Disabled	Disabled
Trunk2			Enabled		Auto	Auto	Disabled	Disabled
Trunk3			Enabled		Auto	Auto	Disabled	Disabled
Trunk4			Enabled		Auto	Auto	Disabled	Disabled
Trunk5			Enabled		Auto	Auto	Disabled	Disabled
Trunk6			Enabled		Auto	Auto	Disabled	Disabled
Trunk7			Enabled		Auto	Auto	Disabled	Disabled
Trunk8			Enabled		Auto	Auto	Disabled	Disabled

Figure 4.41 L2 Switching > Link Aggregation > LAG Port Status

4.5.3.4 LACP Priority Settings

The LACP Priority Settings page allows you to configure the system priority for LACP. To access this page, click **L2 Switching > Link Aggregation > LACP Priority Settings**.

The screenshot shows the 'LACP Priority Settings' configuration page. It features a 'System Priority' input field with the value '32768' and a range indicator '(1-65535)'. Below the input field is a blue 'Apply' button.

Figure 4.42 L2 Switching > Link Aggregation > LACP Priority Settings

The following table describes the items in the previous figure.

Item	Description
System Priority	Enter the value (1-65535) to designate the LACP system priority.
Apply	Click Apply to save the values and update the screen.

The ensuing table for **LACP Information** settings are informational only: System Priority.

4.5.3.5 LACP Port Settings

Link Aggregation Control Protocol (LACP) provides a method to control the bundling of several physical ports together to form a single logical channel. By configuring the LACP function, the switch can negotiate an automatic bundling of links by sending LACP packets to the peer device (also implementing LACP).

To access this page, click **L2 Switching > Link Aggregation > LACP Port Settings**.

The screenshot shows the 'LACP Port Settings' configuration page. It includes a 'Port Select' dropdown menu with 'Select Ports' as the current selection. Below it is a 'Priority' input field with the value '1' and a range indicator '(1-65535)'. There are two radio button options for 'Timeout': 'Long' (selected) and 'Short'. There are two radio button options for 'Mode': 'Active' (selected) and 'Passive'. A blue 'Apply' button is located at the bottom.

Figure 4.43 L2 Switching > Link Aggregation > LACP Port Settings

The following table describes the items in the previous figure.

Item	Description
Port Select	Select a port for the LACP Port Settings. The listed available settings are: FE1-FE8, GE1-GE2. However, the available settings are dependent on the connected LACP device and may not be listed as displayed in the current figure.
Priority	Enter a variable (1 to 65535) to assign a priority to the defined port selection.
Timeout	Click the radio button to select a long or short timeout period.
Mode	Click the radio button to select the setting mode: Active or Passive. <ul style="list-style-type: none"> ■ Active: Enables LACP unconditionally. ■ Passive: Enables LACP only when an LACP device is detected (default state).
Apply	Click Apply to save the values and update the screen.

The following figure displays the **LACP Port Information** settings.

Port Name	Priority	Timeout	Mode
GE1	1	Long	Passive
GE2	1	Long	Passive
GE3	1	Long	Passive
GE4	1	Long	Passive
GE5	1	Long	Passive
GE6	1	Long	Passive
GE7	1	Long	Passive
GE8	1	Long	Passive

Figure 4.44 L2 Switching > Link Aggregation > LACP Port Information Settings

4.5.4 802.1Q VLAN

The 802.1Q VLAN feature allows for a single VLAN to support multiple VLANs. With the 802.1Q feature you can preserve VLAN IDs and segregate different VLAN traffic. The 802.1Q VLAN tag feature encapsulates the 802.1Q VLAN tagging within another 802.1Q VLAN tag. The outer tag is assigned following the AP group, while the inner VLAN ID is assigned dynamically by the AAA server.

4.5.4.1 VLAN Management

The management of VLANs is available through the VLAN Settings page. Through this page you can add or delete VLAN listings and add a prefix name to an added entry.

To access this page, click **L2 Switching > 802.1Q VLAN > VLAN Management**.

Figure 4.45 L2 Switching > 802.1Q VLAN > VLAN Management

The following table describes the items in the previous figure.

Item	Description
VLAN Action	Click the radio button to add or delete the VLAN entry shown in the previous field.
VLAN ID / VLAN List	Enter the name of the VLAN entry to setup.
VLAN Name / VLAN Prefix	Enter the prefix to be used by the VLAN list entry in the previous field.
Apply	Click Apply to save the values and update the screen.

The following figure displays the **VLAN Table** settings.

Figure 4.46 L2 Switching > 802.1Q VLAN > VLAN Table

4.5.4.2 PVID Settings

The PVID Settings page allows you to designate a PVID for a selected port, define the accepted type and enable/disable the ingress filtering.

To access this page, click **L2 Switching > 802.1Q VLAN > PVID Settings**.

Figure 4.47 L2 Switching > 802.1Q VLAN > PVID Settings

The following table describes the items in the previous figure.

Item	Description
Port Select	Click the drop-down menu to select a port and edit its settings: FE1-FE8, GE1-GE2, or Trunk1 - Trunk8.

Item	Description
PVID	Enter the VLAN ID you want assigned to untagged or priority tagged frames received on this port. The value ranges 1 to 4094. The default is 1.
Accepted Type	Click the radio button to specify which frames to forward. Tag Only discards any untagged or priority tagged frames. Untag Only discards any tagged frames. All accepts all untagged and tagged frames. Whichever you select, VLAN tagged frames are forwarded in accordance with the IEEE 802.1Q VLAN standard. The default is All.
Ingress Filtering	Click the radio button to specify how you want the port to handle tagged frames. If you enable Ingress Filtering, a tagged frame will be discarded if this port is not a member of the VLAN identified by the VLAN ID in the tag. If you select Disabled, all tagged frames will be accepted. The default is Disabled.
Apply	Click Apply to save the values and update the screen.

The ensuing table for **Port VLAN Status** settings are informational only: Port, Interface VLAN Mode, PVID, Accept Frame Type and Ingress Filtering.

4.5.4.3 Port to VLAN

The Port to VLAN page allows you to add a port to a VLAN and select the related parameters.

To access this page, click **L2 Switching > 802.1Q VLAN > Port to VLAN**.

VLAN ID :

Port to VLAN Table			
Port	Interface VLAN Mode	Membership	PVID
GE1	Hybrid	<input type="radio"/> Forbidden <input type="radio"/> Excluded <input type="radio"/> Tagged <input checked="" type="radio"/> Untagged	YES
GE2	Hybrid	<input type="radio"/> Forbidden <input type="radio"/> Excluded <input type="radio"/> Tagged <input checked="" type="radio"/> Untagged	YES
GE3	Hybrid	<input type="radio"/> Forbidden <input type="radio"/> Excluded <input type="radio"/> Tagged <input checked="" type="radio"/> Untagged	YES
GE4	Hybrid	<input type="radio"/> Forbidden <input type="radio"/> Excluded <input type="radio"/> Tagged <input checked="" type="radio"/> Untagged	YES
GE5	Hybrid	<input type="radio"/> Forbidden <input type="radio"/> Excluded <input type="radio"/> Tagged <input checked="" type="radio"/> Untagged	YES
GE6	Hybrid	<input type="radio"/> Forbidden <input type="radio"/> Excluded <input type="radio"/> Tagged <input checked="" type="radio"/> Untagged	YES
GE7	Hybrid	<input type="radio"/> Forbidden <input type="radio"/> Excluded <input type="radio"/> Tagged <input checked="" type="radio"/> Untagged	YES
GE8	Hybrid	<input type="radio"/> Forbidden <input type="radio"/> Excluded <input type="radio"/> Tagged <input checked="" type="radio"/> Untagged	YES
GE9	Hybrid	<input type="radio"/> Forbidden <input type="radio"/> Excluded <input type="radio"/> Tagged <input checked="" type="radio"/> Untagged	YES
GE10	Hybrid	<input type="radio"/> Forbidden <input type="radio"/> Excluded <input type="radio"/> Tagged <input checked="" type="radio"/> Untagged	YES
Trunk1	Hybrid	<input type="radio"/> Forbidden <input type="radio"/> Excluded <input type="radio"/> Tagged <input checked="" type="radio"/> Untagged	YES
Trunk2	Hybrid	<input type="radio"/> Forbidden <input type="radio"/> Excluded <input type="radio"/> Tagged <input checked="" type="radio"/> Untagged	YES
Trunk3	Hybrid	<input type="radio"/> Forbidden <input type="radio"/> Excluded <input type="radio"/> Tagged <input checked="" type="radio"/> Untagged	YES
Trunk4	Hybrid	<input type="radio"/> Forbidden <input type="radio"/> Excluded <input type="radio"/> Tagged <input checked="" type="radio"/> Untagged	YES
Trunk5	Hybrid	<input type="radio"/> Forbidden <input type="radio"/> Excluded <input type="radio"/> Tagged <input checked="" type="radio"/> Untagged	YES
Trunk6	Hybrid	<input type="radio"/> Forbidden <input type="radio"/> Excluded <input type="radio"/> Tagged <input checked="" type="radio"/> Untagged	YES
Trunk7	Hybrid	<input type="radio"/> Forbidden <input type="radio"/> Excluded <input type="radio"/> Tagged <input checked="" type="radio"/> Untagged	YES
Trunk8	Hybrid	<input type="radio"/> Forbidden <input type="radio"/> Excluded <input type="radio"/> Tagged <input checked="" type="radio"/> Untagged	YES

Figure 4.48 L2 Switching > 802.1Q VLAN > Port to VLAN

The following table describes the items in the previous figure.

Item	Description
Port	Displays the assigned port to the entry.
Interface VLAN Mode	Displays the Hybrid mode to the listed VLAN port.
Membership	Displays the assigned membership status of the port entry, options include: Forbidden, Excluded Tagged or Untagged.
Apply	Click Apply to save the values and update the screen.

4.5.4.4 Port-VLAN Mapping

The following figure displays the **Port-VLAN Mapping Table** settings.

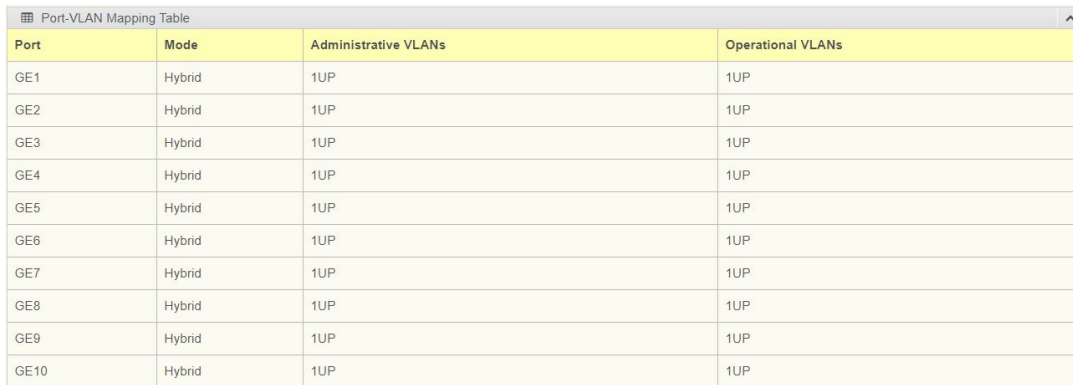

Port	Mode	Administrative VLANs	Operational VLANs
GE1	Hybrid	1UP	1UP
GE2	Hybrid	1UP	1UP
GE3	Hybrid	1UP	1UP
GE4	Hybrid	1UP	1UP
GE5	Hybrid	1UP	1UP
GE6	Hybrid	1UP	1UP
GE7	Hybrid	1UP	1UP
GE8	Hybrid	1UP	1UP
GE9	Hybrid	1UP	1UP
GE10	Hybrid	1UP	1UP

Figure 4.49 L2 Switching > 802.1Q VLAN > Port-VLAN Mapping

4.5.4.5 RSPAN VLAN

The RSPAN VLAN page allows user to process monitoring RSPAN feature of the VLAN. The following figure displays the **RSPAN VLAN Table** settings.



RSPAN VLAN Settings

VLAN ID :

Figure 4.50 L2 Switching > 802.1Q VLAN > RSPAN VLAN Mapping

The following table describes the items in the previous figure.

Item	Description
VLAN ID	Click the drop-down menu to select the corresponding VLAN ID to map.
Apply	Click Apply to save the values and update the screen.

4.5.5 Q-in-Q

Q-in-Q is commonly referred as VLAN stacking in which VLANs are nested by adding two tags to each frame instead of one. Network service provider and users both can use VLANs and makes it possible to have more than the 4094 separate VLANs allowed by 802.1Q.

There are three ways in which a machine can be connected to a network carrying double-tagged 802.1ad traffic:

- via a untagged port, where both inner and outer VLANs are handled by the switch or switches (so the attached machine sees ordinary Ethernet frames);
- via a single-tagged (tunnel) port, where the outer VLAN only is handled by the switch (so the attached machine sees single-tagged 802.1Q VLAN frames); or
- via a double-tagged (trunk) port, where both inner and outer VLANs are handled by the attached machine (which sees double-tagged 802.1ad VLAN frames).

4.5.5.1 Global Settings

The Global Settings page allows you to set the outer VLAN Ethertype setting.

To access this page, click **L2 Switching > Q-in-Q > Global Settings**.

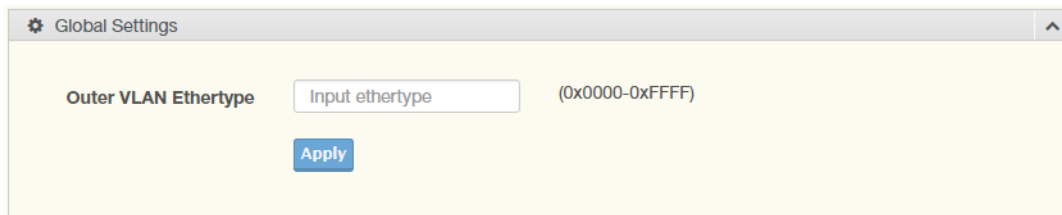

Figure 4.51 L2 Switching > Q-in-Q > Global Settings

The following table describes the items in the previous figure.

Item	Description
Outer VLAN Ether-type	Enter the outer VLAN handled by the switch giving the attached machine a single-tagged 802.1Q VLAN frame.
Apply	Click Apply to save the values and update the screen.

The ensuing table for **QinQ Global Information** settings are informational only: Outer VLAN Ethertype.

4.5.5.2 Port Settings

The Port Settings page allows you to define the outer PVID and outer mode for a selected port.

To access this page, click **L2 Switching > Q-in-Q > Port Settings**.

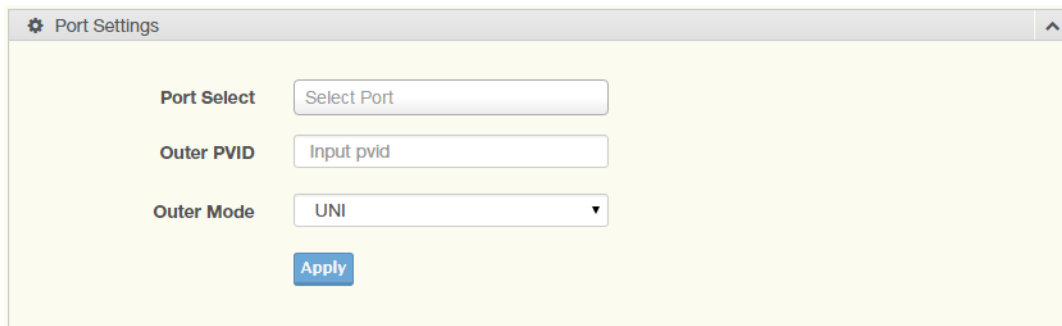

Figure 4.52 L2 Switching > Q-in-Q > Port Settings

The following table describes the items in the previous figure.

Item	Description
Port Select	Enter the switch port (part of VLAN configuration) to configure the selection as a tunnel port.
Outer PVID	Enter the Port VLAN ID (PVID) to assigned the native VLAN ID. All untagged traffic coming in or out of the 802.1Q port is forwarded based on the PVID value
Outer Mode	Click the drop-down menu to select between UNI or NNI role. <ul style="list-style-type: none"> ■ UNI: Selects a user-network interface which specifies communication between the specified user and a specified network. ■ NNI: Selects a network-to-network interface which specifies communication between two specified networks.
Apply	Click Apply to save the values and update the screen.

The following figure displays the **QinQ Port Information** settings.

Port	Outer PVID	Outer Mode
GE1	1	UNI
GE2	1	UNI
GE3	1	UNI
GE4	1	UNI
GE5	1	UNI

Figure 4.53 L2 Switching > QinQ Port Information

4.5.6 GARP

The Generic Attribute Registration Protocol (GARP) is a local area network (LAN) protocol. The protocol defines procedures for the registration and de-registration of attributes (network identifiers or addresses) by end stations and switches with each other.

4.5.6.1 GARP Settings

To access this page, click **L2 Switching > GARP > GARP Settings**.

The screenshot shows the 'GARP Settings' configuration page. It contains three input fields for time values in seconds: 'Join Time' (range 6-600), 'Leave Time' (range 12-3000), and 'Leave All Time' (range 12-12000). Below these fields is a note: 'Join Time * 2 < Leave Time < Leave All Time'. An 'Apply' button is located at the bottom of the form.

Figure 4.54 L2 Switching > GARP > GARP Settings

The following table describes the items in the previous figure.

Item	Description
Join Time	Enter a value to specify the time between the transmission of GARP PDUs registering (or re-registering) membership for a VLAN or multi-cast group in centiseconds. Enter a number between 6 and 600. An instance of this timer exists for each GARP participant for each port.
Leave Time	Enter a value to specify the time to wait after receiving an unregister request for a VLAN or multicast group before deleting the associated entry, in centiseconds. This allows time for another station to assert registration for the same attribute in order to maintain uninterrupted service. Enter a number between 12 and 3000. An instance of this timer exists for each GARP participant for each port.
Leave All Time	Enter a value to specify the Leave All Time controls how frequently Leave All PDUs are generated. A Leave All PDU indicates that all registrations will shortly be deregistered. Participants will need to rejoin in order to maintain registration. The Leave All Period Timer is set to a random value in the range of LeaveAllTime to 1.5*LeaveAllTime. The timer is specified in centiseconds. Enter a number between 12 and 12000. An instance of this timer exists for each GARP participant for each port.
Apply	Click Apply to save the values and update the screen.

The ensuing table for **GARP Information** settings are informational only: Join Time, Leave Time and Leave All Time.

4.5.6.2 GVRP Settings

The GVRP Settings page allows you to enable or disable the GVRP (GARP VLAN Registration Protocol or Generic VLAN Registration Protocol) protocol which facilitates control of virtual local area networks (VLANs) within a larger network.

To access this page, click **L2 Switching > GARP > GVRP Settings**.

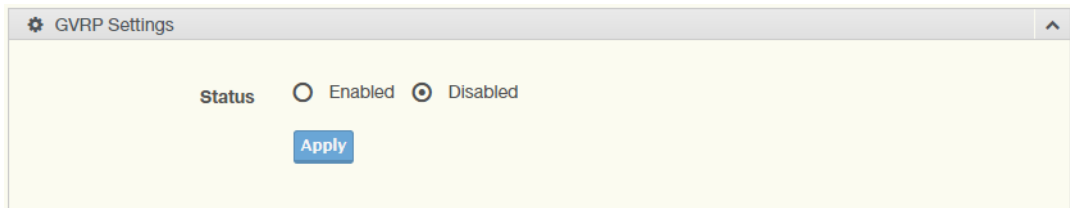

Figure 4.55 L2 Switching > GARP > GVRP Settings

The following table describes the items in the previous figure.

Item	Description
Status	Click to enable or disable the GARP VLAN Registration Protocol administrative mode for the switch. The factory default is Disable.
Apply	Click Apply to save the values and update the screen.

The ensuing table for **GVRP Information** settings are informational only: GVRP.

4.5.6.3 GMRP Settings

To access this page, click **L2 Switching > GARP > GMRP Settings**.

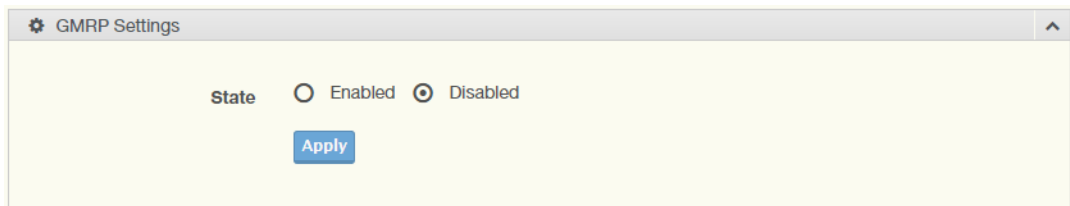

Figure 4.56 L2 Switching > GARP > GMRP Settings

The following table describes the items in the previous figure.

Item	Description
State	Click to enable or disable the GMRP mode for the switch. The factory default is Disable.
Apply	Click Apply to save the values and update the screen.

The ensuing table for **GMRP Information** settings are informational only: GMRP.

The ensuing table for **Multicast Groups** settings are informational only: VLAN ID, MAC Address, Type and Member Ports.

4.5.7 802.3az EEE

The 802.3az Energy Efficient Ethernet (EEE) innovative green feature reduces energy consumption through intelligent functionality:

- Traffic detection — Energy Efficient Ethernet (EEE) compliance
- Inactive link detection

Inactive link detection function automatically reduces power usage when inactive links or devices are detected.

To access this page, click **L2 Switching > 802.3az EEE**.

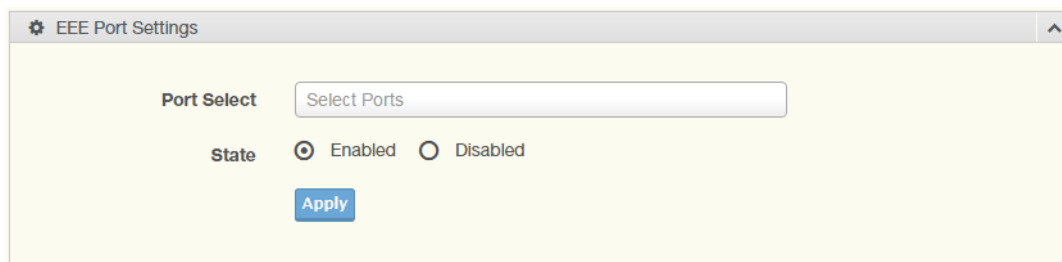

Figure 4.57 L2 Switching > 802.3az EEE

The following table describes the items in the previous figure.

Item	Description
Port Select	Enter the port to setup the EEE function.
State	Click Enabled or Disabled to set the state mode of the port select setting.
Apply	Click Apply to save the values and update the screen.

The ensuing table for **EEE Enable Status** settings are informational only: Port and EEE State.

4.5.8 Multicast

Multicast forwarding allows a single packet to be forwarded to multiple destinations. The service is based on L2 switch receiving a single packet addressed to a specific Multicast address. Multicast forwarding creates copies of the packet, and transmits the packets to the relevant ports.

4.5.8.1 Multicast Filtering

The Multicast Filtering page allows for the definition of action settings when an unknown multicast request is received. The options include: Drop, Flood, or Router Port.

To access this page, click **L2 Switching > Multicast > Multicast Filtering**.

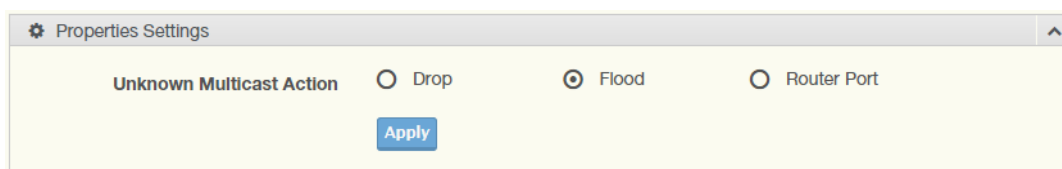

Figure 4.58 L2 Switching > Multicast > Multicast Filtering

The following table describes the items in the previous figure.

Item	Description
Unknown Multicast Action	Select the configuration protocol: Drop, Flood, or Router Port, to apply for any unknown multicast event.
Apply	Click Apply to save the values and update the screen.

The ensuing table for **Properties Information** settings are informational only: Unknown Multicast Action.

4.5.8.2 IGMP Snooping

IGMP Snooping is defined as the process of listening to Internet Group Management Protocol (IGMP) network traffic. IGMP Snooping allows a network switch to listen in on the IGMP conversation between hosts and routers and maintain a map of which

links need which IP multicast streams. Multicasts can be filtered from the links which do not need them in turn controlling which ports receive specific multicast traffic.

IGMP Settings

To access this page, click **L2 Switching > Multicast > IGMP Snooping > IGMP Settings**.

Figure 4.59 L2 Switching > Multicast > IGMP Snooping > IGMP Settings

The following table describes the items in the previous figure.

Item	Description
IGMP Snooping State	Select Enable or Disable to designate the IGMP Snooping State.
IGMP Snooping Version	Select designate the IGMP Snooping Version: V2 or V3.
IGMP Snooping Report Suppression	Select Enable or Disable to setup the report suppression for IGMP Snooping.
Apply	Click Apply to save the values and update the screen.

The following figure displays the **IGMP Snooping Information** settings.

Information Name	Information Value
IGMP Snooping State	Enable
IGMP Snooping Version	v2
IGMP Snooping V2 Report Suppression	Enable

Figure 4.60 L2 Switching > Multicast > IGMP Snooping > IGMP Snooping Information

IGMP Querier

IGMP Querier allows snooping to function by creating the tables for snooping. General queries must be unconditionally forwarded by all switches involved in IGMP snooping.

To access this page, click **L2 Switching > Multicast > IGMP Snooping > IGMP Querier**.

Figure 4.61 L2 Switching > Multicast > IGMP Snooping > IGMP Querier

The following table describes the items in the previous figure.

Item	Description
VLAN ID	Select the VLAN ID to define the local IGMP querier.

Item	Description
Querier State	Select Disable or Enable to configure the VLAN ID (IGMP Querier).
Querier Version	Select the querier version (V2 or V3) designated to the selected VLAN ID.
Apply	Click Apply to save the values and update the screen.

The following figure displays the **IGMP Querier Status** settings.



VLAN ID	Querier State	Querier Status	Querier Version	Querier IP
1	disabled	Non-Querier	---	---

Figure 4.62 L2 Switching > Multicast > IGMP Snooping > IGMP Querier Status

IGMP Static Groups

To access this page, click **L2 Switching > Multicast > IGMP Snooping > IGMP Static Groups**.

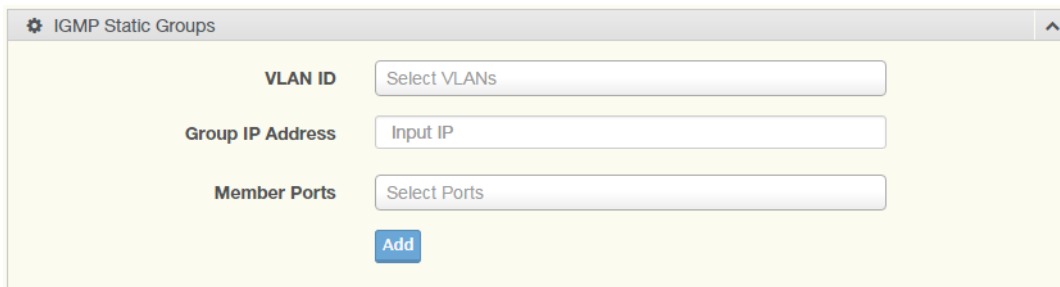

IGMP Static Groups

VLAN ID:

Group IP Address:

Member Ports:

Figure 4.63 L2 Switching > Multicast > IGMP Snooping > IGMP Static Groups

The following table describes the items in the previous figure.

Item	Description
VLAN ID	Select the VLAN ID to define IGMP static group.
Group IP Address	Enter the IP address assigned to the VLAN ID.
Member Ports	Enter the port numbers to associate with the static group.
Add	Click Add to add an IGMP group.

The ensuing table for **IGMP Static Groups Status** settings are informational only: VLAN ID, Group IP Address, Member Ports and Modify.

Multicast Groups

To access this page, click **L2 Switching > Multicast > IGMP Snooping > Multicast Groups**.

The following figure displays the **Multicast Groups** settings.

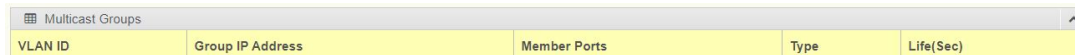

VLAN ID	Group IP Address	Member Ports	Type	Life(Sec)
---------	------------------	--------------	------	-----------

Figure 4.64 L2 Switching > Multicast > IGMP Snooping > Multicast Groups

Router Ports

To access this page, click **L2 Switching > Multicast > IGMP Snooping > Router Ports**.

The following figure displays the **Router Ports** settings.

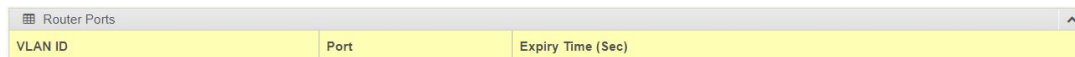

VLAN ID	Port	Expiry Time (Sec)
---------	------	-------------------

Figure 4.65 L2 Switching > Multicast > IGMP Snooping > Router Ports

4.5.8.3 MLD Snooping

The MLD Snooping page allows you to select the snooping status (enable or disable), the version (v1 or v2) and the enabling/disabling of the report suppression for the MLD querier, which sends out periodic general MLD queries and are forwarded through all ports in the VLAN.

MLD Settings

To access this page, click **L2 Switching > Multicast > MLD Snooping > MLD Settings**.

The screenshot shows the 'MLD Snooping Settings' configuration page. It contains three rows of radio button options:

- MLD Snooping State:** Enable, Disable
- MLD Snooping Version:** v1, v2
- MLD Snooping Report Suppression:** Enable, Disable

An **Apply** button is located below the options.

Figure 4.66 L2 Switching > Multicast > MLD Snooping > MLD Settings

The following table describes the items in the previous figure.

Item	Description
MLD Snooping State	Select Enable or Disable to setup the MLD Snooping State.
MLD Snooping Version	Select the querier version (V1 or V2) designated to the MLD Snooping Version.
MLD Snooping Report Suppression	Select Enable or Disable to designate the status of the report suppression.
Apply	Click Apply to save the values and update the screen.

The following figure displays the **MLD Snooping Information** settings.

Information Name	Information Value
MLD Snooping State	Disable
MLD Snooping Version	v1
MLD Snooping V2 Report Suppression	Enable

Figure 4.67 L2 Switching > Multicast > MLD Snooping > MLD Snooping Information

The following figure displays the **MLD Snooping Table** settings.

Entry No.	VLAN ID	MLD Snooping Operation State	Router Ports Auto Learn	Query Robustness	Query Interval(sec.)	Query Max Response Interval(sec.)	Last Member Query count	Last Member Query Interval(sec.)	Immediate Leave	Modify
1	1	disabled	enabled	2	125	10	2	1	disabled	Edit

Figure 4.68 L2 Switching > Multicast > MLD Snooping > MLD Snooping Table

MLD Querier

The MLD Querier page allows you to select and enable/disable the MLD querier and define the version (IGMPv1 or IGMPv2) when enabled.

To access this page, click **L2 Switching > Multicast > MLD Snooping > MLD Querier**.

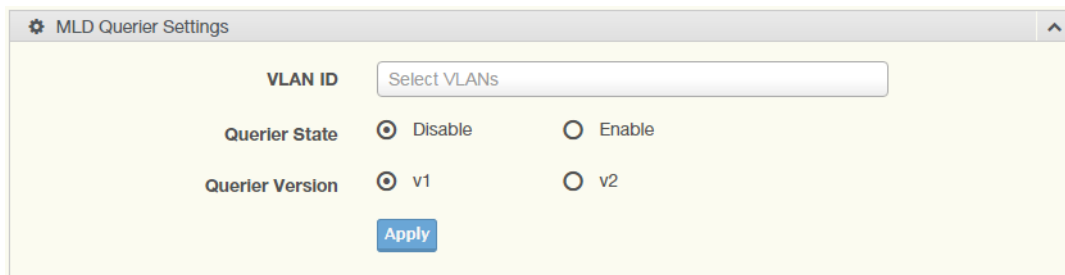

Figure 4.69 L2 Switching > Multicast > MLD Snooping > MLD Querier

The following table describes the items in the previous figure.

Item	Description
VLAN ID	Enter the VLAN ID to configure.
Querier State	Select Enable or Disable status on the selected VLAN. ■ Enable: Enable IGMP Querier Election. ■ Disable: Disable IGMP Querier Election.
Querier Version	Select the querier version (IGMPV1 or IGMPV2) designated to the MLD Querier function.
Apply	Click Apply to save the values and update the screen.

The ensuing table for **MLD Querier Status** settings are informational only: VLAN ID, Querier State, Querier Status, Querier Version and Querier IP.

MLD Static Group

The MLD Static Group page allows you to configure specified ports as static member ports.

To access this page, click **L2 Switching > Multicast > MLD Snooping > MLD Static Group**.

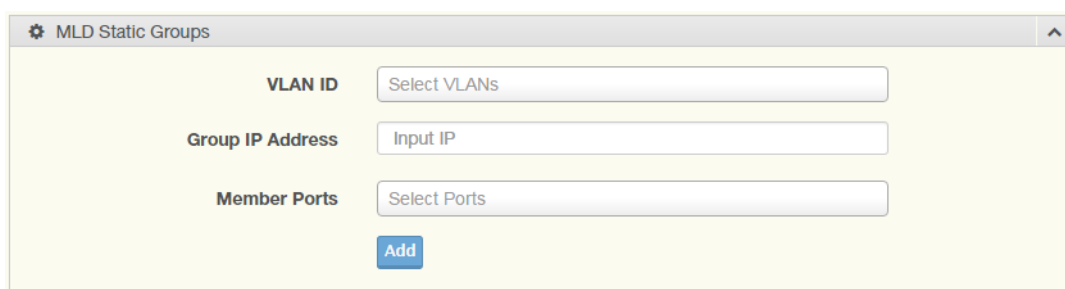

Figure 4.70 L2 Switching > Multicast > MLD Snooping > MLD Static Group

The following table describes the items in the previous figure.

Item	Description
VLAN ID	Enter the VLAN ID to define the local MLD Static Group.
Group IP Address	Enter the IP address associated with the static group.
Member Ports	Enter the ports designated with the static group.
Add	Click Add to add a MLD static group.

The ensuing table for **MLD Static Groups Status** settings are informational only: VLAN ID, Group IP Address, Member Ports and Modify.

Multicast Groups

To access this page, click **L2 Switching > Multicast > MLD Snooping > Multicast Groups**.

The following figure displays the **Multicast Groups** settings.



VLAN ID	Group IP Address	Member Ports	Type	Life(Sec)
---------	------------------	--------------	------	-----------

Figure 4.71 L2 Switching > Multicast > MLD Snooping > Multicast Groups

Router Ports

To access this page, click **L2 Switching > Multicast > MLD Snooping > Router Ports**.

The following figure displays the **Router Ports** settings.



VLAN ID	Port	Expiry Time (Sec)
---------	------	-------------------

Figure 4.72 L2 Switching > Multicast > MLD Snooping > Router Ports

4.5.9 Jumbo Frame

Jumbo frames are frames larger than the standard Ethernet frame size of 1518 bytes. The Jumbo Frame function allows the configuration of Ethernet frame size.

To access this page, click **L2 Switching > Jumbo Frame**.

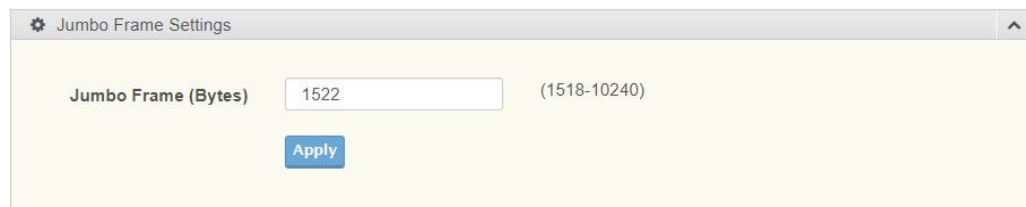

Figure 4.73 L2 Switching > Jumbo Frame

The following table describes the items in the previous figure.

Item	Description
Jumbo Frame (Bytes)	Enter the variable in bytes (1518 to 10240) to define the jumbo frame size.
Apply	Click Apply to save the values and update the screen.

The ensuing table for **Jumbo Frame Config** settings are informational only: Jumbo Frame (Bytes).

4.5.10 Spanning Tree

The Spanning Tree Protocol (STP) is a network protocol to ensure loop-free topology for any bridged Ethernet local area network.

4.5.10.1 STP Global Settings

The STP Global Settings page allows you to set the STP status, select the configuration for a BPDU packet, choose the path overhead, force version and set the configuration revision range.

To access this page, click **L2 Switching > Spanning Tree > STP Global Settings**.

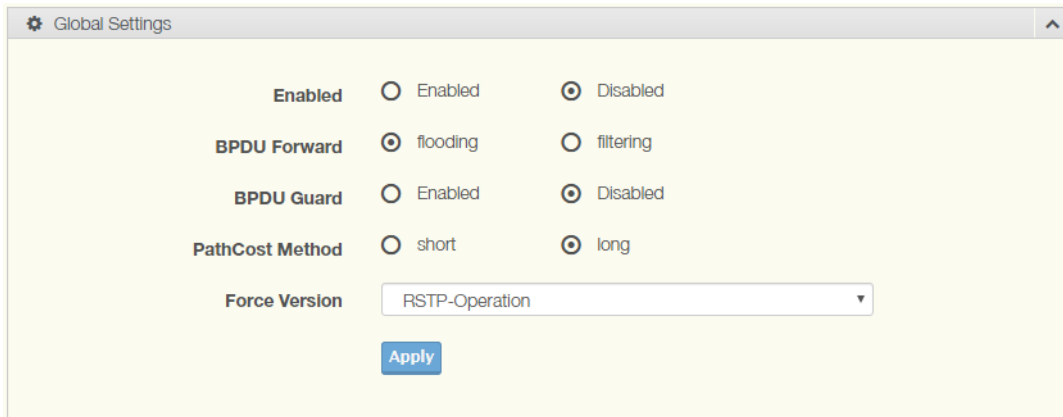

Figure 4.74 L2 Switching > Spanning Tree > STP Global Settings

The following table describes the items in the previous figure.

Item	Description
Enabled	Click the radio-button to enable or disable the STP status.
BPDU Forward	Select flooding or filtering to designate the type of BPDU packet.
BPDU Guard	Click the radio-button to enable or disable the BPDU guard. When enabled, BPDU Guard can disable edge ports that receive BPDU packets. This prevents a new device from entering the existing STP topology. Thus devices that were originally not a part of STP are not allowed to influence the STP topology
PathCost Method	Select short or long to define the method of used for path cost calculations.
Force Version	Click the drop-down menu to select the operating mode for STP. <ul style="list-style-type: none"> ■ STP-Compatible: 802.1D STP operation. ■ RSTP-Operation: 802.1w operation. ■ MSTP-Operation: 802.1s operation.
Apply	Click Apply to save the values and update the screen.

The following figure displays the **STP Information** settings.

Information Name	Information Value
STP	Disabled
BPDU Forward	flooding
BPDU Guard	Disabled
PathCost Method	long
Force Version	RSTP-Operation

Figure 4.75 L2 Switching > Spanning Tree > STP Information

4.5.10.2 STP Port Settings

The STP Port Settings page allows you to configure the ports for the setting, port's contribution, configure edge port, and set the status of the BPDU filter.

To access this page, click **L2 Switching > Spanning Tree > STP Port Settings**.

Figure 4.76 L2 Switching > Spanning Tree > STP Port Settings

The following table describes the items in the previous figure.

Item	Description
Port Select	Select the port list to specify the ports that apply to this setting.
Admin Enable	Select Enabled or Disabled to setup the admin profile for the STP port.
Path Cost (0 = Auto)	Set the port's cost contribution. For a root port, the root path cost for the bridge. (0 means Auto).
Edge Port	Click the drop-down menu to set the edge port configuration. <ul style="list-style-type: none"> ■ No: Force to false state (as link to a bridge). ■ Yes: Force to true state (as link to a host).
P2P MAC	Click the drop-down menu to set the Point-to-Point port configuration. <ul style="list-style-type: none"> ■ No: Force to false state. ■ Yes: Force to true state.
Migrate	Click the check box to enable the migrate function. Forces the port to use the new MST/RST BPDUs, requiring the switch to test on the LAN segment. for the presence of legacy devices, which are not able to understand the new BPDU formats.
Apply	Click Apply to save the values and update the screen.

The ensuing table for **STP Port Status** settings are informational only: Port, Admin Enable, Path Cost, Edge Port and P2P MAC.

4.5.10.3 STP Bridge Settings

The STP Bridge Settings page allows you to configure the priority, forward delay, maximum age, Tx hold count, and the hello time for the bridge.

To access this page, click **L2 Switching > Spanning Tree > STP Bridge Settings**.

Figure 4.77 L2 Switching > Spanning Tree > STP Bridge Settings

The following table describes the items in the previous figure.

Item	Description
Priority	Click the drop-down menu to select the STP bridge priority.
Forward Delay	Enter the variable (4 to 30) to set the forward delay for STP bridge settings.
Max Age	Enter the variable (6 to 40) to set the Max age for STP bridge settings.
Tx Hold Count	Enter the variable (1 to 10) to designate the TX hold count for STP bridge settings.
Hello Time	Enter the variable (1 to 10) to designate the Hello Time for STP bridge settings.
Apply	Click Apply to save the values and update the screen.

The ensuing table for **STP Bridge Information** settings are informational only: Priority, Forward Delay, Max Age, Tx Hold Count and Hello Time.

The ensuing table for **STP Bridge Status** settings are informational only: Bridge Identifier, Designated Root Bridge, Root Path Cost, Designated Bridge, Root Port and Last Topology Change.

4.5.10.4 STP Port Advanced Settings

The STP Port Advanced Settings page allows you to select the port list to apply this setting.

To access this page, click **L2 Switching > Spanning Tree > STP Port Advanced Settings**.

Figure 4.78 L2 Switching > Spanning Tree > STP Port Advanced Settings

The following table describes the items in the previous figure.

Item	Description
Port Select	Select the port to designate the STP settings.

Item	Description
Priority	Click the drop-down menu to designate a priority.
Apply	Click Apply to save the values and update the screen.

The following figure displays the **STP Port Status** settings.

Port	Identifier (Priority / Port Id)	Path Cost Conf/Oper	Designated Root Bridge	Root Path Cost	Designated Bridge	Edge Port Conf/Oper	P2P MAC Conf/Oper	Port Role	Port State
GE1	128 / 1	0 / 20000	0 / 00.00.00.00.00.00	0	0 / 00.00.00.00.00.00	No / No	No / No	Disabled	Disabled
GE2	128 / 2	0 / 20000	0 / 00.00.00.00.00.00	0	0 / 00.00.00.00.00.00	No / No	No / No	Disabled	Disabled
GE3	128 / 3	0 / 20000	0 / 00.00.00.00.00.00	0	0 / 00.00.00.00.00.00	No / No	No / No	Disabled	Disabled
GE4	128 / 4	0 / 20000	0 / 00.00.00.00.00.00	0	0 / 00.00.00.00.00.00	No / No	No / No	Disabled	Disabled
GE5	128 / 5	0 / 20000	0 / 00.00.00.00.00.00	0	0 / 00.00.00.00.00.00	No / No	No / No	Disabled	Disabled
GE6	128 / 6	0 / 20000	0 / 00.00.00.00.00.00	0	0 / 00.00.00.00.00.00	No / No	No / No	Disabled	Disabled
GE7	128 / 7	0 / 20000	0 / 00.00.00.00.00.00	0	0 / 00.00.00.00.00.00	No / No	No / No	Disabled	Disabled
GE8	128 / 8	0 / 20000	0 / 00.00.00.00.00.00	0	0 / 00.00.00.00.00.00	No / No	No / No	Disabled	Disabled

Figure 4.79 L2 Switching > Spanning Tree > STP Port Status

4.5.10.5 MST Config Identification

The MST Config Identification page allows you to configure the identification setting name and the identification range.

To access this page, click **L2 Switching > Spanning Tree > MST Config Identification**.

MST Configuration Identification Settings

Configuration Name

Revision Level (0-65535)

Figure 4.80 L2 Switching > Spanning Tree > MST Config Identification

The following table describes the items in the previous figure.

Item	Description
Configuration Name	Enter the identifier used to identify the configuration currently being used. It may be up to 32 characters.
Revision Level	Enter the identifier for the Revision Configuration, range: 0 to 65535 (default: 0).
Apply	Click Apply to save the values and update the screen.

The ensuing table for **MST Configuration Identification Information** settings are informational only: Configuration Name and Revision Level.

4.5.10.6 MST ID Settings

The MST Instance ID Settings page allows you to edit the MSTI ID and VID List settings.

To access this page, click **L2 Switching > Spanning Tree > MST ID Settings**.

Figure 4.81 L2 Switching > Spanning Tree > MST ID Settings

The following table describes the items in the previous figure.

Item	Description
MSTI ID	Enter the MST instance ID (0-15).
VID List	Enter the pre-configured VID list.
Move	Click Move to save the values and update the screen.

The ensuing table for **MST ID Information** settings are informational only: MSTI ID and VID List.

4.5.10.7 MSTI Priority Settings

The MST Instance Priority Settings allows you to specify the MST instance and the bridge priority in that instance.

To access this page, click **L2 Switching > Spanning Tree > MSTI Priority Settings**.

Figure 4.82 L2 Switching > Spanning Tree > MSTI Priority Settings

The following table describes the items in the previous figure.

Item	Description
MSTI ID	Click the drop-down menu to specify the MST instance.
Priority	Click the drop-down menu set the bridge priority in the specified MST instance
Apply	Click Apply to save the values and update the screen.

The ensuing table for **MSTI Priority Information** settings are informational only: MSTI ID, Priority and Action.

4.5.10.8 MSTI Bridge Info

To access this page, click **L2 Switching > Spanning Tree > MSTI Bridge Info**.

The following figure displays the **STP Bridge Status** settings.

Information Name	Information Value
Bridge Identifier	32768/ 0/C4:00:AD:F2:12:C8
Designated Root Bridge	0/ 0/00:00:00:00:00:00
Root Path Cost	0
Designated Bridge	0/ 0/00:00:00:00:00:00
Root Port	0 / 0
Last Topology Change	0

Figure 4.83 L2 Switching > Spanning Tree > STP Bridge Status

4.5.10.9 MSTI Port Advanced settings

To access this page, click **L2 Switching > Spanning Tree > MSTI Port Advanced**. The following figure displays the **MSTI Port Advanced** settings.

Advanced Settings

MSTI ID:

Port Select:

Priority:

Path Cost (0 = Auto):

Figure 4.84 L2 Switching > Spanning Tree > MSTI Port Advanced settings

4.5.10.10 STP Statistics

To access this page, click **L2 Switching > Spanning Tree > STP Statistics**. The following figure displays the **STP Statistics** settings.

Port	Configuration BPDUs Received	TCN BPDUs Received	Configuration BPDUs Transmitted	TCN BPDUs Transmitted
GE1	0	0	0	0
GE2	0	0	0	0
GE3	0	0	0	0
GE4	0	0	0	0
GE5	0	0	0	0
GE6	0	0	0	0
GE7	0	0	0	0
GE8	0	0	0	0
GE9	0	0	0	0

Figure 4.85 L2 Switching > Spanning Tree > STP Statistics

4.5.11 X-Ring Elite

The X-Ring Elite function provides an improvement over Spanning Tree and Rapid Spanning Tree and a rapid auto recovery in the event that the network suffers a corrupt or broken link and prevents network loops.

4.5.11.1 X-Ring Elite Settings

The X-Ring Elite Settings allows you to enable or disable the state of the X-Ring settings.

To access this page, click **L2 Switching > X-Ring Elite > X-Ring Elite Settings**.

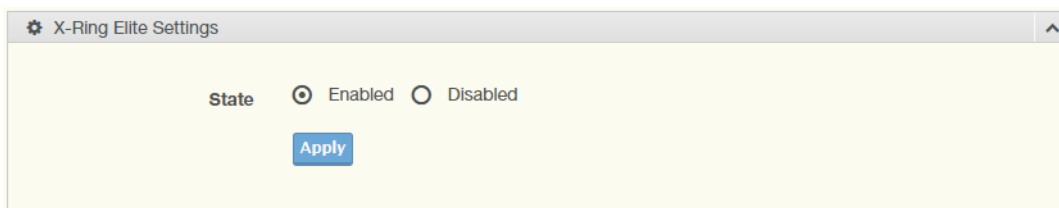

Figure 4.86 L2 Switching > X-Ring Elite > X-Ring Elite Settings

The following table describes the items in the previous figure.

Item	Description
State	Select Enabled or Disabled to setup the X-Ring Elite mode.
Apply	Click Apply to save the values and update the screen.

The ensuing table for **Information** settings are informational only: X-Ring Elite State.

4.5.11.2 X-Ring Elite Groups

The X-Ring Elite Groups page allows you to select the function and role for each device and the connected ports.

To access this page, click **L2 Switching > X-Ring Elite > X-Ring Elite Groups**.



Figure 4.87 L2 Switching > X-Ring Elite > X-Ring Elite Groups

The following table describes the items in the previous figure.

Item	Description
Ring ID	Enter a number to specifies a ranging from 1 to 255 to identify a given X-Ring Elite group.
Role	Click the drop-down menu to select the ring role.
Port 1	Click the drop-down menu to define the port designation.
Port 2	Click the drop-down menu to define the port designation.
Add	Click Add to save the values and update the screen.

The ensuing table for **Information** settings are informational only: Ring ID, Role, Port 1, Port 2 and **Delete** (click to delete the desired Ring ID).

4.5.12 X-Ring Pro

The X-Ring Pro function provides an improvement over Spanning Tree and Rapid Spanning Tree and a rapid auto recovery in the event that the network suffers a corrupt or broken link and prevents network loops.

4.5.12.1 X-Ring Pro Settings

The X-Ring Pro Settings page allows you to configure the status (enabled or disabled) of the function.

To access this page, click **L2 Switching > X-Ring Pro > X-Ring Pro Settings**.

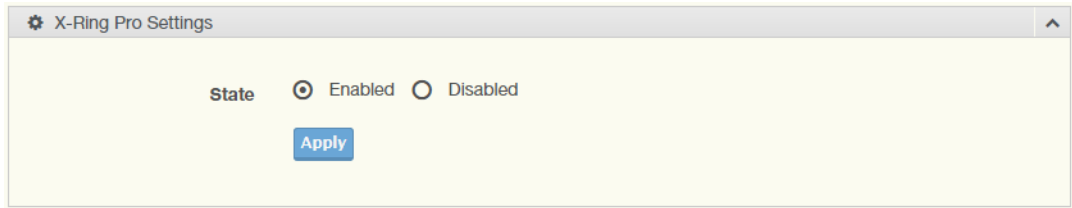

Figure 4.88 L2 Switching > X-Ring Pro > X-Ring Pro Settings

The following table describes the items in the previous figure.

Item	Description
State	Select Enabled or Disabled to setup the X-Ring Pro mode.
Apply	Click Apply to save the values and update the screen.

The ensuing table for **Information** settings are informational only: X-Ring Pro State.

4.5.12.2 X-Ring Pro Groups

The X-Ring Pro Groups page allows you to select the function and role for each ring ID and its connected ports.

To access this page, click **L2 Switching > X-Ring Pro > X-Ring Pro Groups**.

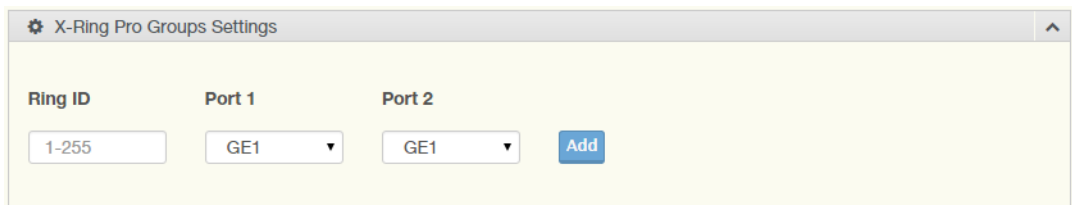

Figure 4.89 L2 Switching > X-Ring Pro > X-Ring Pro Groups > X-Ring Pro Groups Settings

The following table describes the items in the previous figure.

Item	Description
Ring ID	Enter a number to specifies a ranging from 1 to 255 to identify a given X-Ring Pro group.
Port 1	Click the drop-down menu to define the port designation.
Port 2	Click the drop-down menu to define the port designation.
Add	Click Add to save the values and update the screen.

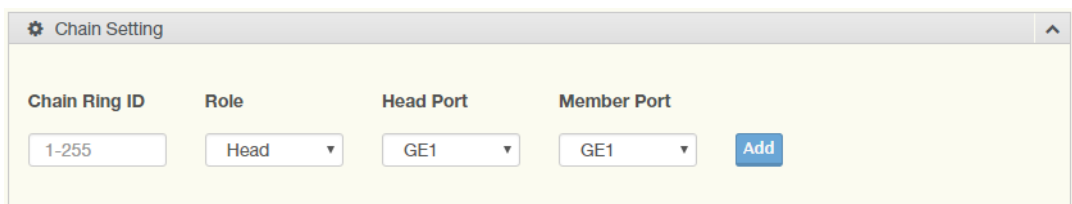

Figure 4.90 L2 Switching > X-Ring Pro > X-Ring Pro Groups > Chain Settings

The following table describes the items in the previous figure.

Item	Description
Chain Ring ID	Enter a number to specifies a ranging from 1 to 255 to identify a chain ring ID.
Role	Click the drop-down menu to select the ring role.
Head Port	Click the drop-down menu to define the port designation.

Item	Description
Member Port	Click the drop-down menu to define the port designation.
Add	Click Add to save the values and update the screen.

Figure 4.91 L2 Switching > X-Ring Pro > X-Ring Pro Groups > Couple Setting
The following table describes the items in the previous figure.

Item	Description
Couple Ring ID	Enter a number to specifies a ranging from 1 to 255 to identify a given X-Ring group.
Port	Enter the port to assign to define the couple setting.
Master Ring ID	Click the drop-down menu to designate the master ring.
Add	Click Add to save the values and update the screen.

Figure 4.92 L2 Switching > X-Ring Pro > X-Ring Pro Groups > Pair Settings
The following table describes the items in the previous figure.

Item	Description
Pair Ring ID	Enter a number to specifies a ranging from 1 to 255 to identify a pair ring ID.
Port	Enter the port to assign to define the couple setting.
Master Ring ID	Click the drop-down menu to designate the master ring.
Add	Click Add to save the values and update the screen.

Figure 4.93 L2 Switching > X-Ring Pro > X-Ring Pro Groups > RPair Settings
The following table describes the items in the previous figure.

Item	Description
RPair Ring ID	Enter a number to specifies a ranging from 1 to 255 to identify a Rpair ring ID.
Port	Enter the port to assign to define the couple setting.

Item	Description
Master Ring ID	Click the drop-down menu to designate the master ring.
Add	Click Add to save the values and update the screen.

The ensuing table for **Information** settings are informational only: Ring ID, Mode, Role, Operation State, Port 1, Forwarding State, Port 2, Forwarding State and **Delete** (click to delete the desired Ring ID).

4.5.13 Loopback Detection

The Loopback Detection function is used to detect looped links. By sending detection frames and then checking to see if the frames returned to any port on the device, the function is used to detect loops.

4.5.13.1 Global Settings

The Global Settings page allows you to configure the state (enabled or disabled) of the function, select the interval at which frames are transmitted and the delay before recovery.

To access this page, click **L2 Switching > Loopback Detection > Global Settings**.

Figure 4.94 L2 Switching > Loopback Detection > Global Settings

The following table describes the items in the previous figure.

Item	Description
State	Select Enabled or Disabled to setup the loopback mode.
Interval	Enter the variable in seconds (1 to 32767) to set the interval at which frames are transmitted.
Recover Time	Enter the variable in seconds (60 to 1000000) to define the delay before recovery.
Apply	Click Apply to save the values and update the screen.

To access this page, click **L2 Switching > Loopback Detection > Loopback Detection Global Information**.

The following figure displays the **Loopback Detection Global Information** settings.

Information Name	Information Value
State	Disabled
Interval	1
Recover Time	60

Figure 4.95 L2 Switching > Loopback Detection > Loopback Detection Global Information

4.5.13.2 Port Settings

The Port Settings page allows you to select ports that are detected by the loopback detection function and configure their status (enabled or disabled).

To access this page, click **L2 Switching > Loopback Detection > Port Settings**.

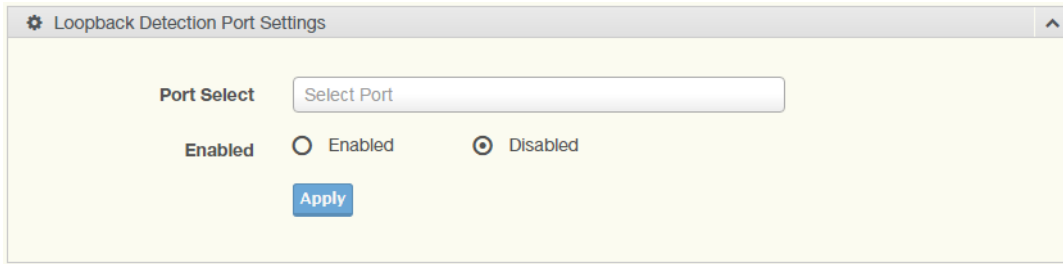

Figure 4.96 L2 Switching > Loopback Detection > Port Settings

The following table describes the items in the previous figure.

Item	Description
Port Select	Enter the port to define the local loopback detection setting.
Enabled	Select Enabled or Disabled to setup the Loopback Detection function.
Apply	Click Apply to save the values and update the screen.

The ensuing table for **Loopback Detection Port Information** settings are informational only: Port, Enable State and Loop Status.

4.5.14 ERPS

4.5.14.1 ERPS Settings

To access this page, click **L2 Switching > ERPS > ERPS Settings**.

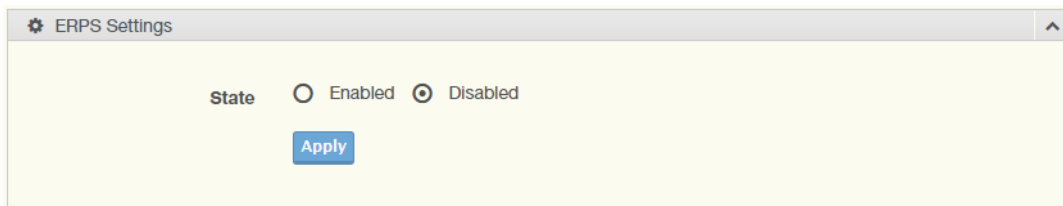

Figure 4.97 L2 Switching > ERPS > ERPS Settings

The following table describes the items in the previous figure.

Item	Description
State	Click Enabled or Disabled to enable ERPS settings.
Apply	Click Apply to save the values and update the screen.

The ensuing table for **Information** settings are informational only: ERPS State.

4.5.14.2 ERPS Groups

To access this page, click **L2 Switching > ERPS > ERPS Groups**.

Figure 4.98 L2 Switching > ERPS > ERPS Groups

The following table describes the items in the previous figure.

Item	Description
ERP Instance	Enter the value to set the ERP instance.
Ring ID	Enter the value to set the ring ID.
Role	Click the drop down menu to select the role. Options include: RPL Owner, RPL Neighbor or Other.
East Link	Enter the port to define the east link.
RPL	Check the check box to enable RPL.
West Link	Enter the port to define the west link.
RPL	Check the check box to enable RPL.
MEL	Enter the value to set minimum equipment list.
R-APS Channel VLAN	Click the drop down menu to select the VLAN.
Traffic Channel Instance	Click the drop down menu to select the traffic channel instance.
Type	Click the drop down menu to select the ERP group type.
WTR Timer	Enter the value to set WTR timer.
Guard Timer	Enter the value to set guard timer.
Hold-off Timer	Enter the value to set hold-off timer.
Apply	Click Apply to save the values and update the screen.

The ensuing table for **Information** settings are informational only: ERP Instance, Ring ID, Role, State, East Link, West Link, MEL, R-APS Channel VLAN, Traffic Channel Instance, Type, WTR Timer, Guard Timer, Hold-off Timer and Delete (Click **Delete** to delete the desired Ring ID).

4.6 MAC Address Table

The MAC Address Table provides access to the Static MAC Settings, MAC Aging Time, and Dynamic Forwarding.

4.6.1 Static MAC

The Static MAC page allows you to configure the address for forwarding of packets, the VLAN ID of the listed MAC address and the designated Port.

To access this page, click **MAC Address Table > Static MAC**.

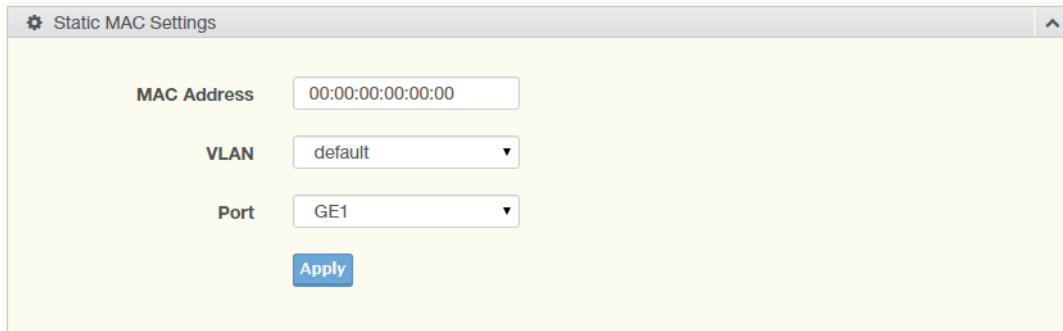

Figure 4.99 MAC Address Table > Static MAC

The following table describes the items in the previous figure.

Item	Description
MAC Address	Enter the MAC address to which packets are statically forwarded.
VLAN	Click the drop-down menu to select the VLAN ID number of the VLAN for which the MAC address is residing.
Port	Click the drop-down menu to select the port number.
Apply	Click Apply to save the values and update the screen.

To access this page, click **MAC Address Table > Static MAC Status**.

The following figure displays the **Static MAC Status** settings.

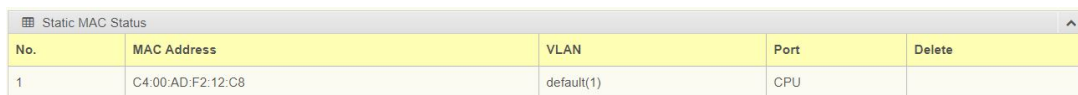

No.	MAC Address	VLAN	Port	Delete
1	C4:00:AD:F2:12:C8	default(1)	CPU	

Figure 4.100 MAC Address Table > Static MAC Status

4.6.2 MAC Aging Time

The MAC Aging Time page allows you to set the MAC address of the aging time to study.

To access this page, click **MAC Address Table > MAC Aging Time**.

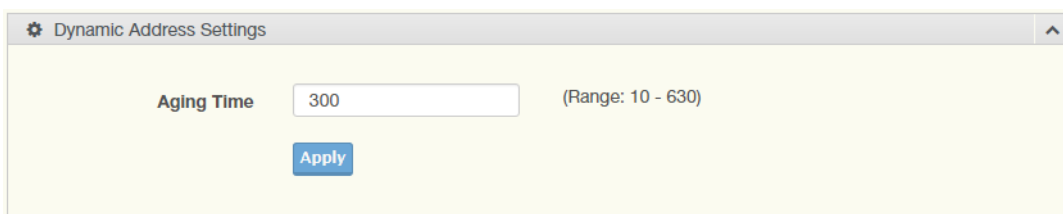

Figure 4.101 MAC Address Table > MAC Aging Time

The following table describes the items in the previous figure.

Item	Description
Aging Time	Enter the variable (10 to 630) to define the time required for aging.
Apply	Click Apply to save the values and update the screen.

The ensuing table for **Dynamic Address Status** settings are informational only: Aging time.

4.6.3 Dynamic Forwarding Table

The Dynamic Forwarding function allows you to configure an address tables, which contain the following:

- The port each hardware address is associated with
- The VLAN to show or clear dynamic MAC entries
- The MAC address selection

To access this page, click **MAC Address Table > Dynamic Forwarding Table**.

Figure 4.102 MAC Address Table > Dynamic Forwarding Table

The following table describes the items in the previous figure.

Item	Description
Port	Click the drop-down menu to select the port number to show or clear dynamic MAC entries. If a port, VLAN or MAC address is not selected the whole dynamic MAC table is displayed or cleared.
VLAN	Click the drop-down menu to select the VLAN to show or clear dynamic MAC entries.
MAC Address	Enter the MAC address to show or clear dynamic MAC entries. If a port, VLAN or MAC address is not selected the whole dynamic MAC table is displayed or cleared.
View	Click View to display the MAC address information.
Clear	Click Clear to clear the MAC Address Information table.

To access this page, click **MAC Address Table > MAC Address Information**.

The following figure displays the **MAC Address Information** settings.

Figure 4.103 MAC Address Table > MAC Address Information

4.7 Security

The Security function allows for the configuration of Storm Control, Port Security, Protected Ports, DoS Prevention, Applications, 802.1x, and IP Security.

4.7.1 Storm Control

The Storm Control page allows you to setup the units and Preamble/IFG to manage the occurrence of packet flooding on the LAN and consequent traffic to prevent the degrading of network performance.

4.7.1.1 Global Settings

To access this page, click **Security > Storm Control > Global Settings**.

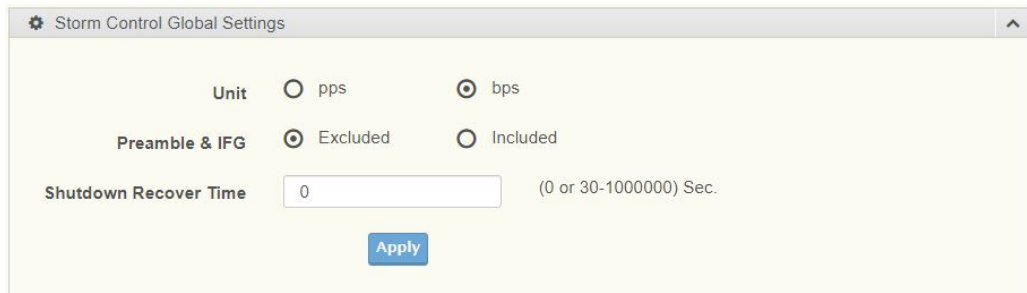

The screenshot shows the 'Storm Control Global Settings' window. It contains three sections: 'Unit' with radio buttons for 'pps' and 'bps' (where 'bps' is selected); 'Preamble & IFG' with radio buttons for 'Excluded' and 'Included' (where 'Excluded' is selected); and 'Shutdown Recover Time' with a text input field containing '0' and a label '(0 or 30-1000000) Sec.'. An 'Apply' button is located at the bottom center.

Figure 4.104 Security > Storm Control > Global Settings

The following table describes the items in the previous figure.

Item	Description
Unit	Select pps or bps control units for the Storm Control function.
Preamble & IFG	Select Excluded or Included to setup the Storm Control Global settings. <ul style="list-style-type: none">■ Excluded: exclude preamble & IFG (20 bytes) when count ingress storm control rate.■ Included: include preamble & IFG (20 bytes) when count ingress storm control rate.
Shutdown Recover Time	Enter the shutdown recover time in seconds with range 0 or 30 ~ 10000000.
Apply	Click Apply to save the values and update the screen.

To access this page, click **Security > Storm Control > Storm Control Global Information**.

The following figure displays the **Storm Control Global Information** settings.

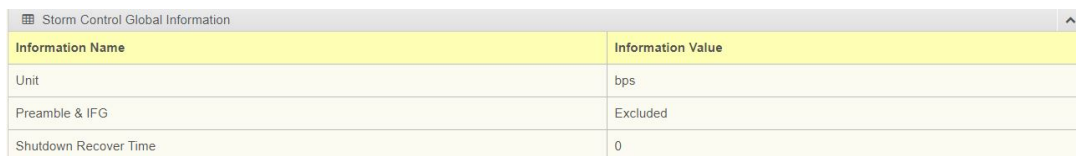

The screenshot shows the 'Storm Control Global Information' window with a table. The table has two columns: 'Information Name' and 'Information Value'. The rows are: Unit (bps), Preamble & IFG (Excluded), and Shutdown Recover Time (0).

Information Name	Information Value
Unit	bps
Preamble & IFG	Excluded
Shutdown Recover Time	0

Figure 4.105 Security > Storm Control > Storm Control Global Information

4.7.1.2 Port Settings

The Port Settings page allows you to configure the port and the type of storm control association along with the value of the storm rate for the selected port.

To access this page, click **Security > Storm Control > Port Settings**.

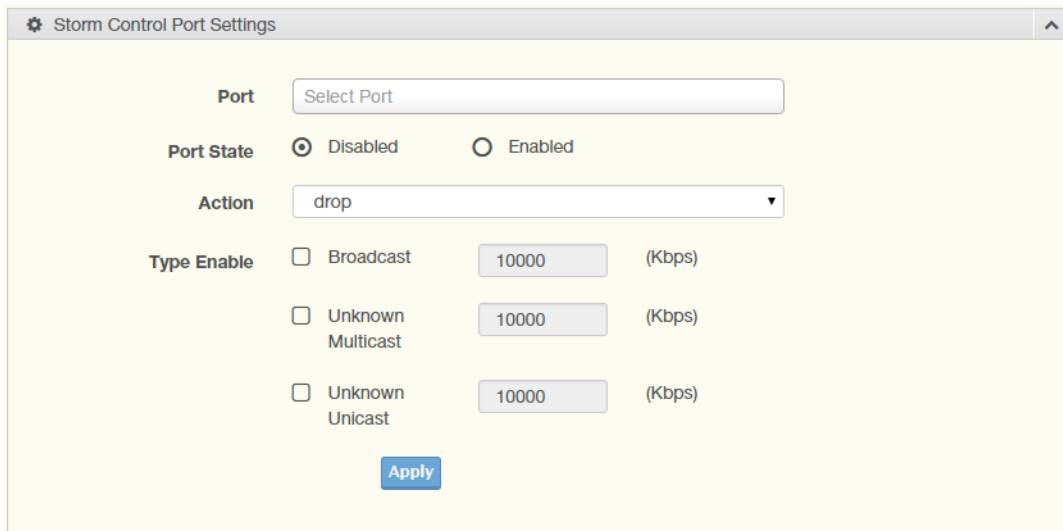

Figure 4.106 Security > Storm Control > Port Settings

The following table describes the items in the previous figure.

Item	Description
Port	Enter the port number to designate the local port for the Storm Control function.
Port State	Select Disabled or Enabled to define the port state
Action	Click the drop-down menu to select the type of action to designate for the selected port during a Storm Control incident. The options are Drop and Shutdown.
Type Enable	Click the radio button to enable Broadcast, Unknown Multicast, or Unknown Unicast. <ul style="list-style-type: none"> ■ Broadcast: Select the variable in Kbps to define the broadcast bandwidth. ■ Unknown Multicast: Select the variable in Kbps to define the unknown multicast setting. ■ Unknown Unicast: Select the variable in Kbps to define the unknown unicast setting.
Apply	Click Apply to save the values and update the screen.

The ensuing table for Storm Control Port Information settings are informational only: Port, Port State, Broadcast (Kbps), Unknown Multicast (Kbps), Unknown Unicast (Kbps) and Action.

The following figure displays the **Storm Control Port Information** settings.

Port	Port State	Broadcast (Kbps)	Unknown Multicast (Kbps)	Unknown Unicast (Kbps)	Action
GE1	Disabled	Off (10000)	Off (10000)	Off (10000)	Drop
GE2	Disabled	Off (10000)	Off (10000)	Off (10000)	Drop
GE3	Disabled	Off (10000)	Off (10000)	Off (10000)	Drop
GE4	Disabled	Off (10000)	Off (10000)	Off (10000)	Drop
GE5	Disabled	Off (10000)	Off (10000)	Off (10000)	Drop

Figure 4.107 Security > Storm Control > Storm Control Port Information

4.7.2 Port Security

The Port Security page allows you to configure port isolation behavior.

To access this page, click **Security > Port Security**.

Figure 4.108 Security > Port Security

The following table describes the items in the previous figure.

Item	Description
Port Select	Enter a single or multiple port numbers to configure.
Enabled	Select Enabled or Disabled to define the selected Port.
FDB Learn Limit (0-64)	Enter the variable (0 to 64) to set the learn limit for the FDB setting.
Violation MAC Notification	Select Enabled or Disabled to define the selected Port.
Apply	Click Apply to save the values and update the screen.

The ensuing table for **Port Security Information** settings are informational only: Port, Enabled, FDB Learn Limit and Violation MAC Notification.

4.7.3 Protected Ports

The Protected Port page allows you to configure a single or multiple ports as a protected or unprotected type.

To access this page, click **Security > Protected Ports**.

Figure 4.109 Security > Protected Ports

The following table describes the items in the previous figure.

Item	Description
Port List	Enter the port number to designate for the Protected Port setting.
Port Type	Select Unprotected or Protected to define the port type.
Apply	Click Apply to save the values and update the screen.

The ensuing table for **Protected Ports Status** settings are informational only: Protected Ports and Unprotected Ports.

4.7.4 DoS Prevention

The DoS Prevention page allows you to setup (enabled or disabled) the denial of service.

4.7.4.1 DoS Global Settings

The DoS Global Settings page allows you to configure (enabled or disabled) the setting for each function.

To access this page, click **Security > DoS Prevention > DoS Global Settings**.

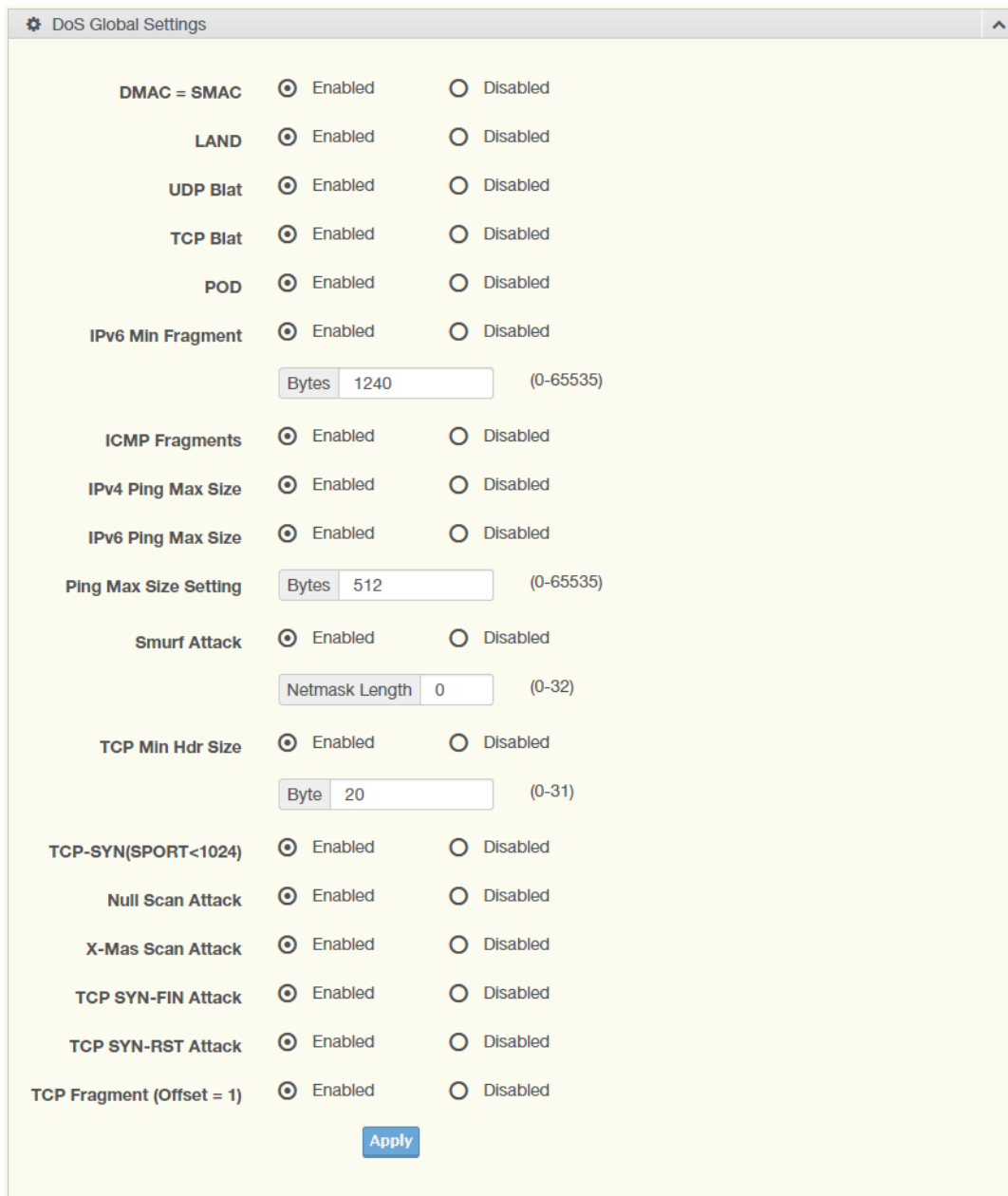

Figure 4.110 Security > DoS Prevention > DoS Global Settings

The following table describes the items in the previous figure.

Item	Description
DMAC = SMAC	Click Enabled or Disabled to define DMAC-SMAC for the DoS Global settings.
LAND	Click Enabled or Disabled to define LAND for the DoS Global settings.
UDP Blat	Click Enabled or Disabled to define UDP Blat for the DoS Global settings.
TCP Blat	Click Enabled or Disabled to define TCP Blat for the DoS Global settings.
POD	Click Enabled or Disabled to define POD for the DoS Global settings.

Item	Description
IPv6 Min Fragment	Click Enabled or Disabled to define minimum fragment size for the IPv6 protocol. Enter the variable in bytes (0 to 65535) to set the minimum fragment size when the function is enabled.
ICMP Fragments	Click Enabled or Disabled to define the ICMP Fragments function.
IPv4 Ping Max Size	Click Enabled or Disabled to set the maximum ping size for the IPv4 protocol.
IPv6 Ping Max Size	Click Enabled or Disabled to set a maximum ping size for the IPv6 protocol.
Ping Max Size Setting	Enter the variable in bytes (0 to 65535) to set the maximum ping size.
Smurf Attack	Click Enabled or Disabled to set the Smurf Attack function.
TCP Min Hdr Size	Click Enabled or Disabled to set the minimum header size. Enter the variable in bytes (0 to 31) to set the minimum header size.
TCP-SYN (SPORT < 1024)	Click Enabled or Disabled to set the TCP synchronization function (sport < 1021).
Null Scan Attack	Click Enabled or Disabled to set the Null Scan Attack function.
X-Mas Scan Attack	Click Enabled or Disabled to set the X-Mas Scan function.
TCP SYN-FIN Attack	Click Enabled or Disabled to set the TCP synchronization termination attack function.
TCP SYN-RST Attack	Click Enabled or Disabled to set the TCP synchronization reset attack function.
TCP Fragment (Offset = 1)	Click Enabled or Disabled to set the TCP fragment function (offset =1).
Apply	Click Apply to save the values and update the screen.

To access this page, click **Security > DoS Prevention > DoS Global Information**. The following figure displays the **DoS Global Information** settings.

Information Name	Information Value
DMAC = SMAC	Enabled
Land Attack	Enabled
UDP Blat	Enabled
TCP Blat	Enabled
POD (Ping of Death)	Enabled
IPv6 Min Fragment Size	Enabled (1240 Bytes)
ICMP Fragment Packets	Enabled
IPv4 Ping Max Packet Size	Enabled (512 Bytes)
IPv6 Ping Max Packet Size	Enabled (512 Bytes)
Smurf Attack	Enabled (Netmask Length: 0)
TCP Min Header Length	Enabled (20 Bytes)
TCP Syn (SPORT < 1024)	Enabled
Null Scan Attack	Enabled
X-Mas Scan Attack	Enabled

Figure 4.111 Security > Storm Control > DoS Global Information

4.7.4.2 DoS Port Settings

The DoS Port Settings page allow you to configure DoS security (enabled or disabled) for the selected port.

To access this page, click **Security > DoS Prevention > DoS Port Settings**.

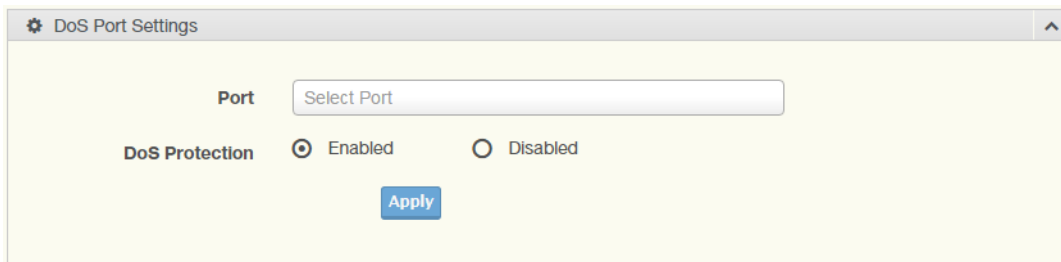

Figure 4.112 Security > DoS Prevention > DoS Port Settings

The following table describes the items in the previous figure.

Item	Description
Port	Select the port to configure for the DoS prevention function.
DoS Protection	Click Enabled or Disabled to set the DoS Port security function state.
Apply	Click Apply to save the values and update the screen.

The ensuing table for **DoS Port Status** settings are informational only: Port and DoS Protection.

4.7.5 Applications

The Applications function allows you to configure various types of AAA lists.

4.7.5.1 TELNET

The TELNET page allows you to combine all kinds of AAA lists with the Telnet line. To access this page, click **Security > Applications > TELNET**.

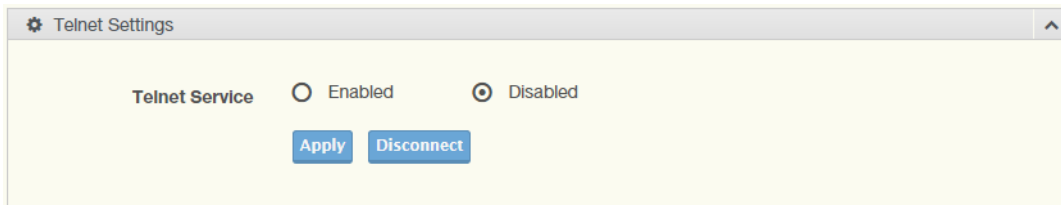

Figure 4.113 Security > Applications > TELNET

The following table describes the items in the previous figure.

Item	Description
Telnet Service	Click Enabled or Disabled to set remote access through the Telnet Service function.
Apply	Click Apply to save the values and update the screen.
Disconnect	Click Disconnect to disable the current Telnet service.

The ensuing table for **Telnet Information** settings are informational only: Telnet Service and Current Telnet Sessions Count.

4.7.5.2 SSH

Secure Shell (SSH) is a protocol providing secure (encrypted) management connection to a remote device.

To access this page, click **Security > Applications > SSH**.

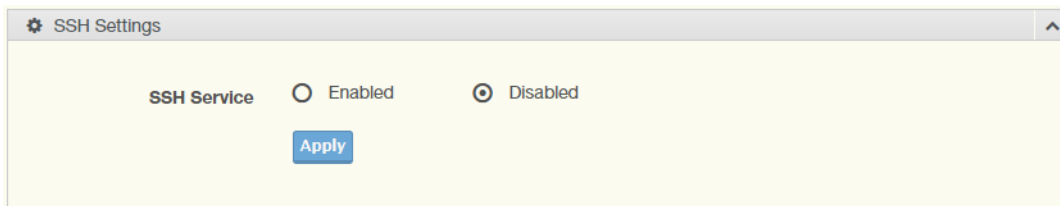

Figure 4.114 Security > Applications > SSH

The following table describes the items in the previous figure.

Item	Description
SSH Service	Click Enabled or Disabled to set up Ethernet encapsulation (remote access) through the Secure Shell (SSH) function.
Apply	Click Apply to save the values and update the screen.

The ensuing table for **SSH Information** settings are informational only: SSH.

4.7.5.3 HTTP

The HTTP page allows you to combine all kinds of AAA lists to the HTTP line. Attempts to access the switch's Web UI from HTTP are first authenticated.

To access this page, click **Security > Applications > HTTP**.

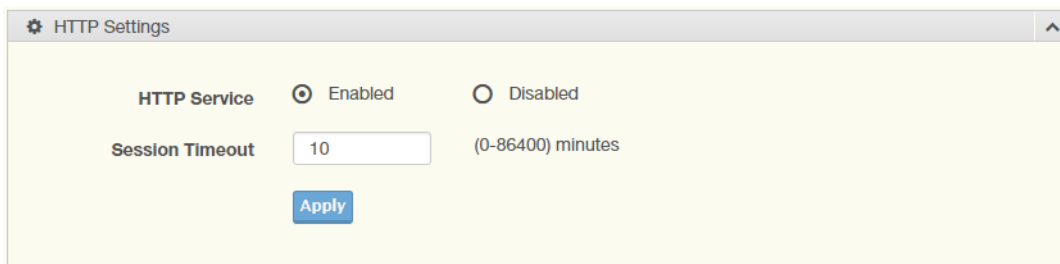

Figure 4.115 Security > Applications > HTTP

The following table describes the items in the previous figure.

Item	Description
HTTP Service	Click Enabled or Disabled to set up Ethernet encapsulation (remote access) through HTTP function.
Session Timeout	Enter the variable in minutes (0 to 86400) to define the timeout period for the HTTP session.
Apply	Click Apply to save the values and update the screen.

The ensuing table for **HTTP Information** settings are informational only: HTTP Service and Session Timeout.

4.7.5.4 HTTPS

The HTTPS page allows you to combine all kinds of AAA lists on the HTTPS line. Attempts to access the switch's Web UI from HTTPS are first authenticated.

To access this page, click **Security > Applications > HTTPS**.

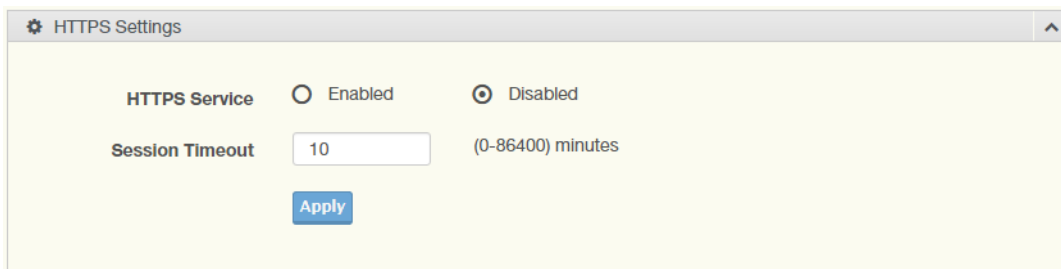

Figure 4.116 Security > Applications > HTTPS

The following table describes the items in the previous figure.

Item	Description
HTTPS Service	Click Enabled or Disabled to set up Ethernet encapsulation over HTTPS.
Session Timeout	Enter the variable in minutes (0 to 86400) to define the timeout period for the HTTP session.
Apply	Click Apply to save the values and update the screen.

The ensuing table for **HTTPS Information** settings are informational only: HTTPS Service and Session Timeout.

4.7.6 802.1x

The 802.1x function provides port-based authentication to prevent unauthorized devices (clients) from gaining access to the network.

4.7.6.1 802.1x Global Settings

The 802.1x Global Settings page allows you to set the state (enabled or disabled) for the selected IP server address, port, accounting port and associated password, including a reauthentication period.

To access this page, click **Security > 802.1x > 802.1x Global Settings**.

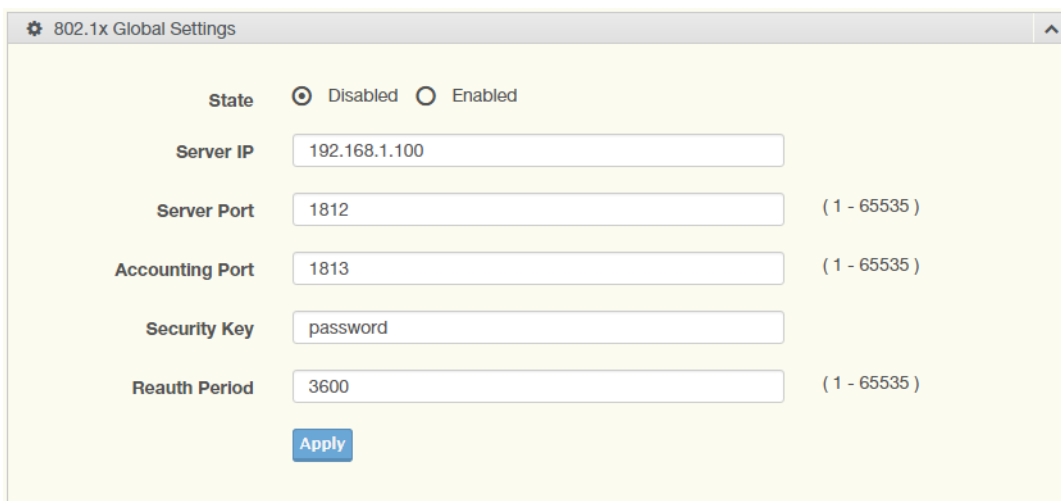

Figure 4.117 Security > 802.1x > 802.1x Global Settings

The following table describes the items in the previous figure.

Item	Description
State	Click Enabled or Disabled to set up 802.1x Setting function.
Server IP	Enter the IP address of the local server providing authentication function.

Item	Description
Server Port	Enter the port number (1 to 65535) assigned to the listed Server IP.
Accounting Port	Enter the port number (1 to 65535) assigned to the listed server IP configured to provide authorization and authentication for network access.
Security Key	Enter the variable to define the network security key used in authentication.
Reauth Period	Enter the variable in seconds to define the period of time between authentication attempts.
Apply	Click Apply to save the values and update the screen.

To access this page, click **Security > 802.1x > 802.1x Information**.

The following figure displays the **802.1x Information** settings.

Information Name	Information Value
802.1xState	Disabled
Server IP	192.168.1.100
Server Port	1812
Accounting Port	1813
Security Key	password
Reauth Period	3600

Figure 4.118 Security > 802.1x > 802.1x Information

4.7.6.2 802.1x Port Configuration

The 802.1x Port Configuration page allows you to identify the authorization state for a port by using a MAC or Port authentication base.

To access this page, click **Security > 802.1x > 802.1x Port Configuration**.

802.1x Port Configuration

Authentication based: Port Mac Mac-Auth-Bypass

Port Select:

State: Authorize Disabled

Figure 4.119 Security > 802.1x > 802.1x Port Configuration

The following table describes the items in the previous figure.

Item	Description
Authentication based	Click Port , Mac or Mac-Auth-Bypass to designate the type of configuration for the 802.1x Port setting.
Port Select	Enter the port number associated with the configuration setting.
State	Click Authorize or Disabled to define the listed port's state mode.
Apply	Click Apply to save the values and update the screen.

The ensuing table for **802.1x Port Authorization** settings are informational only: Port and Port State.

4.7.7 IP Security

This section provides you a means to configure the IP Security settings.

4.7.7.1 Global Settings

The Global Settings page allows you to set the IP Security status (enabled or disabled).

To access this page, click **Security > IP Security > Global Settings**.

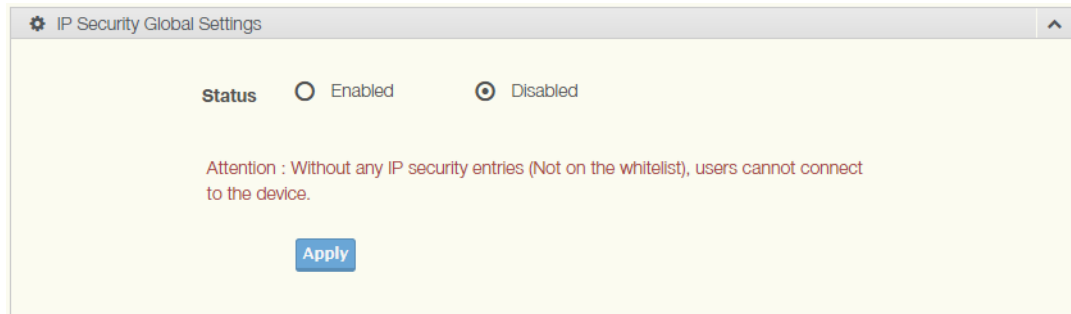

Figure 4.120 Security > IP Security > Global Settings

The following table describes the items in the previous figure.

Item	Description
Status	Click Enabled or Disabled to define the global setting for the IP security function.
Apply	Click Apply to save the values and update the screen.

The ensuing table for **IP Security Status** settings are informational only: IP Security.

4.7.7.2 Entry Settings

Once the Global Setting is enabled, use the Entry Settings to define an IP Security entry.

To access this page, click **Security > IP Security > Entry Settings**.

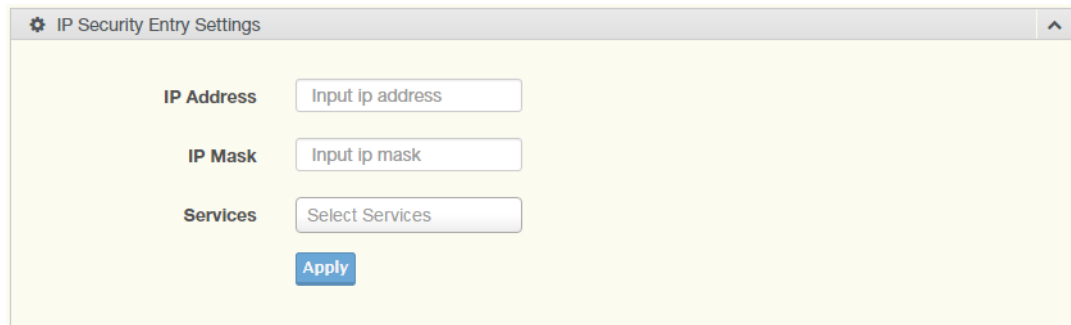

Figure 4.121 Security > IP Security > Entry Settings

The following table describes the items in the previous figure.

Item	Description
IP Address	Enter the source IP address to apply the IP Security function.
IP Mask	Enter the IP address for use in masking the previous IP Address.
Services	Enter the type of services to associate with the entry setting.
Apply	Click Apply to save the values and update the screen.

The ensuing table for **IP Security Entry Information** settings are informational only: IP Address, IP Mask, Services and Action.

4.7.8 Security Login

4.7.8.1 Global Settings

This function provides a means to enable or disable the global security settings for the system.

To access this page, click **Security > Security Login > Global Settings**.

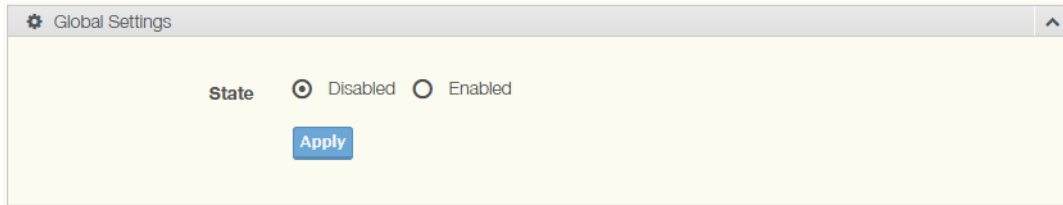

Figure 4.122 Security > Security Login > Global Settings > Global Settings

The following table describes the items in the previous figure.

Item	Description
State	Click Enabled or Disabled to set up security login global setting status.
Apply	Click Apply to save the values and update the screen.

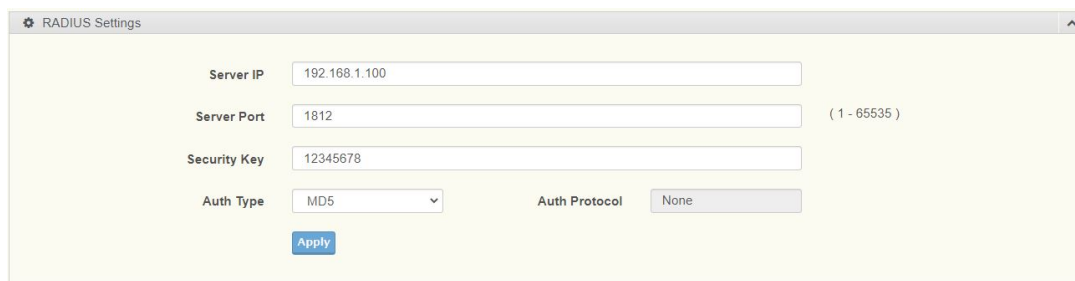

Figure 4.123 Security > Security Login > Global Settings > RADIUS Settings

The following table describes the items in the previous figure.

Item	Description
Server IP	Enter the IP address of the local server providing authentication function.
Server Port	Enter the port number (1 to 65535) assigned to the listed Server IP.
Security Key	Enter the variable to define the network security key used in authentication.
Auth Type	Click the drop down menu to select the Authentication type with option MD5, TTLS or PEAP. Each authentication type is mapping to specified authentication protocol as below: <ul style="list-style-type: none">■ MD5: Using authentication protocol with None.■ TTLS: Using authentication protocol with TTLS.■ PEAP: Using authentication protocol with PEAP.
Apply	Click Apply to save the values and update the screen.

Figure 4.124 Security > Security Login > Global Settings > TACACS Settings
The following table describes the items in the previous figure.

Item	Description
Server IP	Enter the IP address of the local server providing authentication function.
Server Port	Enter the port number (1 to 65535) assigned to the listed Server IP.
Security Key	Enter the variable to define the network security key used in authentication.
Apply	Click Apply to save the values and update the screen.

To access this page, click **Security > Security Login > Global Settings > Global Information**.

The following figure displays the **Global Information** settings.

Information Name	Information Value
State	Disabled
RADIUS Configuration	
Server IP	192.168.1.100
Server Port	1812
Security Key	12345678
Auth Type	MD5
Auth Protocol	None
TACACS Configuration	
Server IP	192.168.1.100
Server Port	1812
Security Key	12345678

Figure 4.125 Security > Security Login > Global Settings > Global Information

4.7.8.2 Access Control Settings

This function specifies the login authentication type for the system.

To access this page, click **Security > Security Login > Security Login Access Control Settings**.

Figure 4.126 Security > Security Login > Access Control Settings > Security Login Type Settings

The following table describes the items in the previous figure.

Item	Description
Login Type	Click to select the login type. Options include: None Used, RADIUS Only, TACACS Only, RADIUS & TACACS or RADIUS & TACACS & WEB.
Apply	Click Apply to save the values and update the screen.

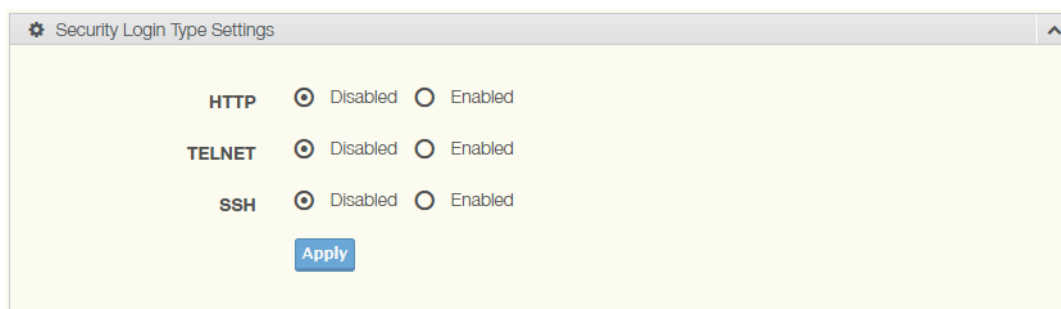

Figure 4.127 Security > Security Login > Access Control Settings > Security Login Type Settings

The following table describes the items in the previous figure.

Item	Description
HTTP	Click Enabled or Disabled to set up HTTP.
TELNET	Click Enabled or Disabled to set up HTTPS.
SSH	Click Enabled or Disabled to set up SSH.
Apply	Click Apply to save the values and update the screen.

To access this page, click **Security > Security Login > Access Control Settings > Global Information**.

The following figure displays the **Access Control Information** settings.

Information Name	Information Value
Login Type	None Used
HTTP	Disabled
TELNET	Disabled
SSH	Disabled

Figure 4.128 Security > Security Login > Access Control Settings > Access Control Information

4.7.9 Access Control List

The Access Control List is the basic traffic filter for ingress and egress packets. Allow user to filter criteria for diverse protocols and deny access to specific source or destination IP/MAC addresses.

4.7.9.1 MAC ACL Entry Settings

To access this page, click **Security > Access Control List > MAC ACL > Entry Settings**.

Figure 4.129 Security > Access Control List > MAC ACL > Entry Settings

The following table describes the items in the previous figure.

Item	Description
Entry ID	Type in the value designating the entry ID.
Destination MAC Address	Enter the MAC address to set destination MAC address.
Destination MAC Mask	Enter a value to specify the subnet mask for the destination MAC address.
Source MAC Address	Enter the MAC address to set source MAC address.
Source MAC Mask	Enter a value to specify the subnet mask for the source MAC address.
Ether Type	Enter a value to specify the DNS server for the interface.
VLAN ID	Type in the value designating the VLAN ID.
Portlist	Select the port to configure for the MAC ACL function.
Action	Click the drop down menu to select the MAC ACL action. Options include: Permit, Drop, Assign Queue, Redirect Port or Redirect Port-list.
Assign Queue	Click the drop down menu to select the queue. The function is only available when Action is Assign Queue .
Status	Click the drop down menu to select the MAC ACL status. Options include: Active or Inactive.
Add	Click Add to add a MAC ACL entry.

Entry List

To access this page, click **Security > Access Control List > MAC ACL > Entry List**. The following figure displays the **Entry List** settings.



Figure 4.130 Security > Access Control List > MAC ACL > Entry List

4.7.9.2 IP ACL

Entry Settings

To access this page, click **Security > Access Control List > IP ACL > Entry Settings**.

The screenshot shows the "Entry Settings" configuration page. It contains several input fields and dropdown menus: "Entry ID" (text input, range 1-250), "Destination IP Address" (text input, example 192.168.1.1), "Destination IP Mask" (text input, example 255.255.0.0), "Source IP Address" (text input, example 192.168.2.1), "Source IP Mask" (text input, example 255.255.0.0), "IP Protocol" (dropdown menu, currently set to "none"), "L4 Destination Port" (text input, range 1-65535), "L4 Source Port" (text input, range 1-65535), "Portlist" (text input, placeholder "Select Port"), "Action" (dropdown menu, currently set to "Permit"), and "Status" (dropdown menu, currently set to "Active"). There is an "Add" button at the bottom.

Figure 4.131 Security > Access Control List > IP ACL > Entry Settings

The following table describes the items in the previous figure.

Item	Description
Entry ID	Type in the value designating the entry ID.
Destination IP Address	Enter the IP address to set destination IP address.
Destination IP Mask	Enter a value to specify the subnet mask for the destination IP address.
Source IP Address	Enter the IP address to set source IP address.
Source IP Mask	Enter a value to specify the subnet mask for the source IP address.
IP Protocol	Click the drop down menu to select the IP protocol. Options include: none, ICMP, TCP or UDP.
L4 Destination Port	Enter a value to specify the L4 destination port.
L4 Source Port	Enter a value to specify the L4 source port.

Item	Description
Portlist	Select the port to configure for the IP ACL function.
Action	Click the drop down menu to select the IP ACL action. Options include: Permit, Drop or Assign Queue.
Assign Queue	Click the drop down menu to select the queue. The function is only available when Action is Assign Queue .
Status	Click the drop down menu to select the IP ACL status. Options include: Active or Inactive.
Add	Click Add to add an IP ACL entry.

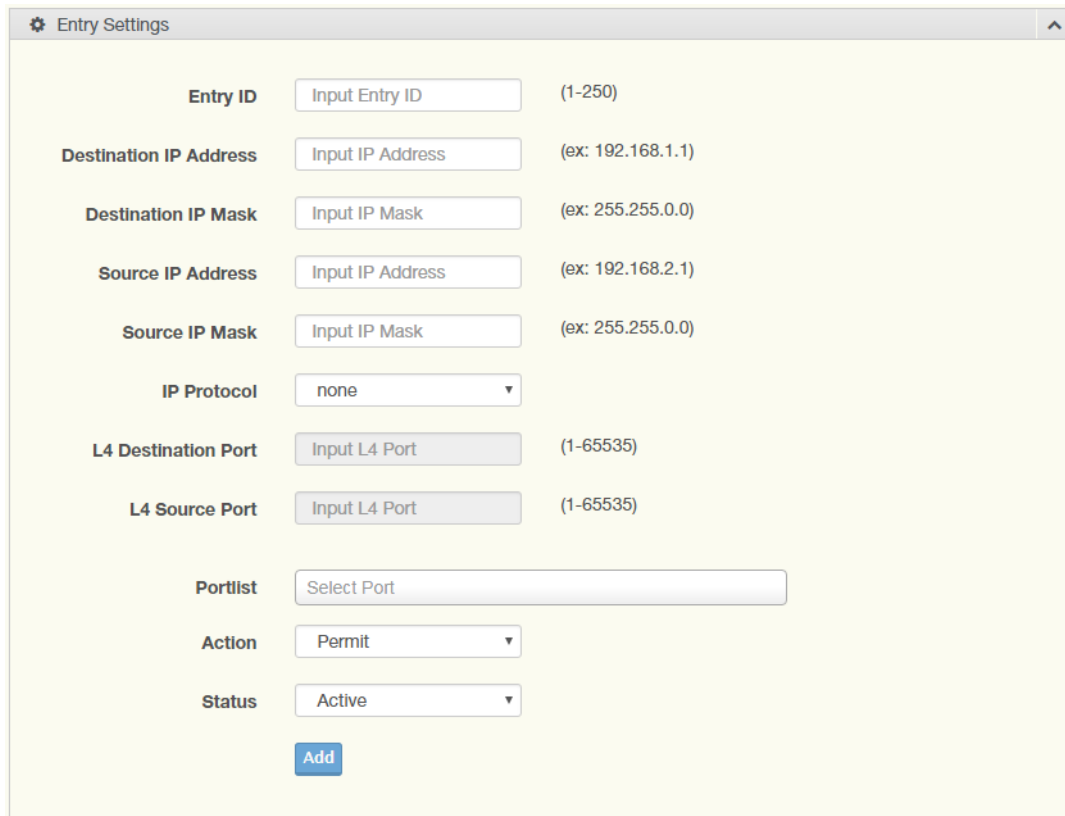
Entry List

To access the Entry List, click **Security > Access Control List > IP ACL > Entry List**.

The ensuing figure for IP ACL Information settings are informational only: Entry ID, Summary, Portlist, Action, Status and Modify (Click Edit to edit the desire entry id or Delete to remove the desired entry id).

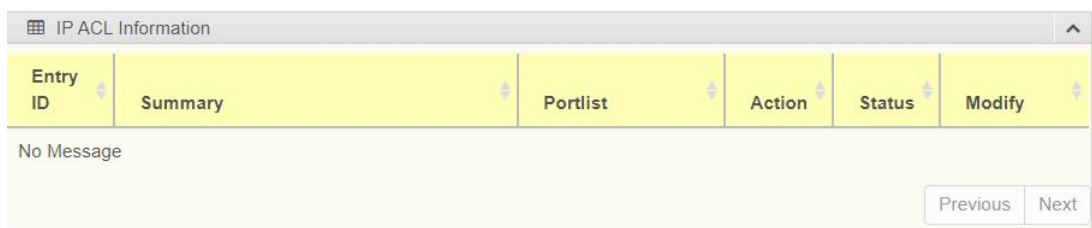

Figure 4.132 Security > Access Control List > IP ACL > Entry List

4.7.10 IP Source Guard

4.7.10.1 Global Settings

To access this page, click **Security > IP Source Guard > Global Settings**.



Figure 4.133 Security > IP Source Guard > Global Settings

The following table describes the items in the previous figure.

Item	Description
Portlist	Select the port to verify.
Modify	Click Modify to save the values and update the screen.

The following figure displays the **Global Information** settings.

Global Information	
Information Name	Information Value
State	Disabled
RADIUS Configuration	
Server IP	192.168.1.100
Server Port	1812
Security Key	12345678
Auth Type	MD5
Auth Protocol	None
TACACS Configuration	
Server IP	192.168.1.100
Server Port	1812
Security Key	12345678

Figure 4.134 Security > IP Source Guard > Global Information

4.7.10.2 Entry Settings

To access this page, click **Security > IP Source Guard > Entry Settings**.

Entry Settings

Source MAC Address (ex: 00:11:22:33:44:55)

Source IP Address (ex: 192.168.2.1)

Port

Figure 4.135 Security > IP Source Guard > Entry Settings

The following table describes the items in the previous figure.

Item	Description
Source MAC Address	Enter the MAC address to set source MAC address.
Source IP Address	Enter the IP address to set source IP address.
Port	Select the port to configure for the IP source guard.
Add	Click Add to add an IP source guard.

To access this page, click **Security > IP Source Guard > Entry Information**.

The following figure displays the **Entry Information** settings.

Entry Information			
Source MAC	Source IP	Port	Modify
No Message			
			Previous Next

Figure 4.136 Security > IP Source Guard > Entry Information

4.7.11 DHCP Snooping

4.7.11.1 Global Settings

To access this page, click **Security > DHCP Snooping > Global Settings**.

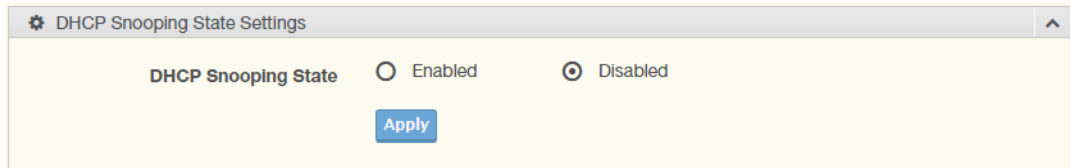

The screenshot shows a configuration window titled "DHCP Snooping State Settings". It features a "DHCP Snooping State" section with two radio buttons: "Enabled" (which is selected) and "Disabled". Below the radio buttons is a blue "Apply" button.

Figure 4.137 Security > DHCP Snooping > Global Settings > DHCP Snooping State Settings

The following table describes the items in the previous figure.

Item	Description
DHCP Snooping State	Click Enabled or Disabled to set DHCP snooping state.
Apply	Click Apply to save the values and update the screen.

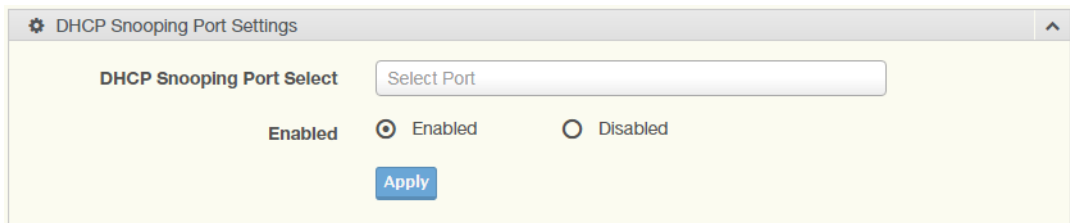

The screenshot shows a configuration window titled "DHCP Snooping Port Settings". It features a "DHCP Snooping Port Select" section with a "Select Port" dropdown menu. Below the dropdown are two radio buttons: "Enabled" (which is selected) and "Disabled". Below the radio buttons is a blue "Apply" button.

Figure 4.138 Security > DHCP Snooping > Global Settings > DHCP Snooping Port Settings

The following table describes the items in the previous figure.

Item	Description
DHCP Snooping Port Select	Select the port to configure for the DHCP Snooping port.
Enabled	Click Enabled or Disabled to enable DHCP Snooping port.
Apply	Click Apply to save the values and update the screen.

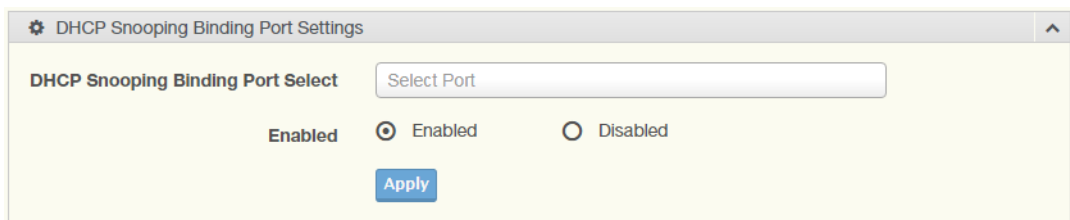

The screenshot shows a configuration window titled "DHCP Snooping Binding Port Settings". It features a "DHCP Snooping Binding Port Select" section with a "Select Port" dropdown menu. Below the dropdown are two radio buttons: "Enabled" (which is selected) and "Disabled". Below the radio buttons is a blue "Apply" button.

Figure 4.139 Security > DHCP Snooping > Global Settings > DHCP Snooping Binding Port Settings

The following table describes the items in the previous figure.

Item	Description
DHCP Snooping Binding Port Select	Select the port to configure for the DHCP snooping binding port.
Enabled	Click Enabled or Disabled to enable DHCP Snooping binding.
Apply	Click Apply to save the values and update the screen.

To access this page, click **Security > DHCP Snooping > Global Settings > DHCP Snooping Information**.

The following figure displays the **DHCP Snooping Information** settings.

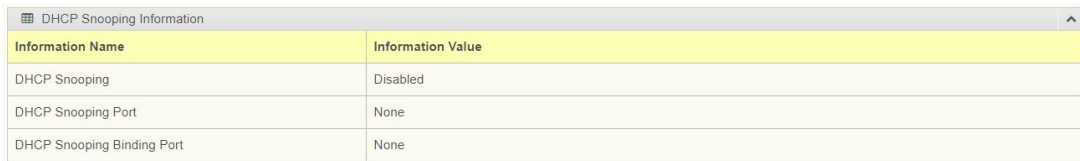

Information Name	Information Value
DHCP Snooping	Disabled
DHCP Snooping Port	None
DHCP Snooping Binding Port	None

Figure 4.140 Security > DHCP Snooping > Global Settings > DHCP Snooping Information

4.7.11.2 Entry Settings

To access this page, click **Security > DHCP Snooping > Entry Settings**.

The following figure displays the **IP Security Entry Information** settings.



MAC Address	IP Address	Lease Time	VLAN Id	Port
No Message				

Figure 4.141 Security > DHCP Snooping > Entry Settings > Entry Information

4.7.11.3 L2-Relay State Settings

To access this page, click **Security > DHCP Snooping > L2-Relay Settings**.

The following figure displays the **L2-Relay State** settings.



L2-Relay State Enabled Disabled

Figure 4.142 Security > DHCP Snooping > L2-Relay Settings

The following table describes the items in the previous figure.

Item	Description
L2-Relay State	Click Enable or Disable to set the function state.
Apply	Click Apply to save the values and update the screen.

To access this page, click **Security > DHCP Snooping > L2-Relay Port Settings**.

The following figure displays the **L2-Relay Port** settings.

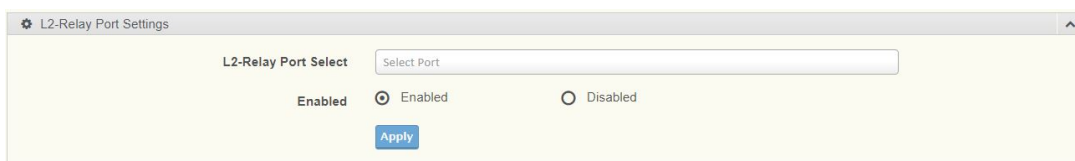

L2-Relay Port Select

Enabled Enabled Disabled

Figure 4.143 Security > DHCP Snooping > L2-Relay Port Settings

The following table describes the items in the previous figure.

Item	Description
L2-Relay Port Select	Enter the port number to add the corresponding port to the relay.
Enabled	Click Enable or Disable to set the function state.
Apply	Click Apply to save the values and update the screen.

To access this page, click **Security > DHCP Snooping > L2-Relay VLAN Settings**.

The following figure displays the **L2-Relay VLAN** settings.

Figure 4.144 Security > DHCP Snooping > L2-Relay VLAN Settings

The following table describes the items in the previous figure.

Item	Description
L2-Relay VLAN List	Enter the port number to add the corresponding port to the relay.
Enabled	Click Enable or Disable to set the function state.
Apply	Click Apply to save the values and update the screen.

To access this page, click **Security > DHCP Snooping > Circuit ID Settings**.

The following figure displays the **Circuit ID Settings & Remote ID** settings.

Figure 4.145 Security > DHCP Snooping > Circuit ID Settings

The following table describes the items in the previous figure.

Item	Description
Circuit ID Type	Enter the port number to add the corresponding port to the relay.
Circuit-ID User-Define String	Click Enable or Disable to set the function state.
Remote ID Type	Remote ID type: Select the remote ID type to be user-define or reserved. <ul style="list-style-type: none"> ■ User-define: Manually specify a remote ID type. ■ Reserved: Set up the remote ID type by reserved format.
Remote-ID User-Define String	Enter the string variable (max. 64 characters) to correspond to the user defined Remote-ID entry when User-define is selected.
Apply	Click Apply to save the values and update the screen.

To access this page, click **Security > DHCP Snooping > L2 Relay Information**. The following figure displays the **L2 Relay Information** settings.

Information Name	Information Value
L2-Relay State	Disabled
L2-Relay Enable Port	
L2-Relay Enable VLAN	
L2-Relay Circuit-ID Type	User-Define
L2-Relay Circuit-ID User-Define String	
L2-Relay Remote-ID Type	User-Define
L2-Relay Remote-ID User-Define String	

Figure 4.146 Security > DHCP Snooping > L2 Relay Information

The following table describes the items in the previous figure.

4.7.12 ARP Spoofing

To access this page, click **Security > ARP Spoofing**.

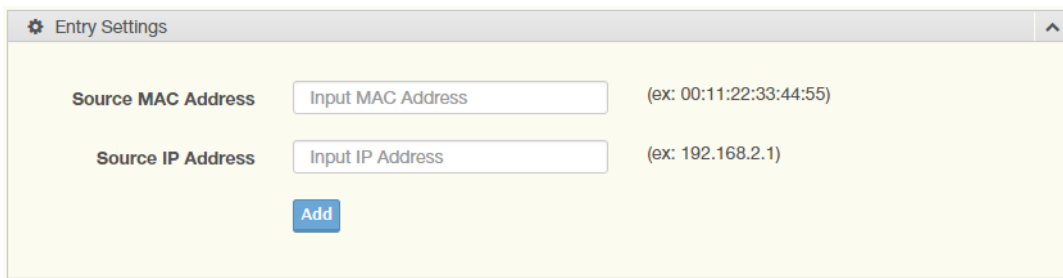

Figure 4.147 Security > ARP Spoofing

The following table describes the items in the previous figure.

Item	Description
Source MAC Address	Enter the MAC address to set source MAC address.
Source IP Address	Enter the IP address to set source IP address.
Add	Click Add to add an ARP spoofing.

To access this page, click **Security > Entry Information**.

The following figure displays the **Entry Information** settings.



Figure 4.148 Security > Entry Information

The following table describes the items in the previous figure.

4.8 QoS

The QoS function allows you to configure settings for the switch QoS interface and how the switch connects to a remote server to get services.

4.8.1 General

Traditionally, networks operate on a best-effort delivery basis, all traffic has equal priority and an equal chance of being delivered in a timely manner. When there is congestion, all traffic has an equal chance of being dropped.

The QoS feature can be configured for congestion-management and congestion-avoidance to specifically manage the priority of the traffic delivery. Implementing QoS in the network makes performance predictable and bandwidth utilization much more effective.

The QoS implementation is based on the prioritization values in Layer 2 frames.

4.8.1.1 QoS Properties

The QoS Properties allows you to set the QoS mode.

To access this page, click **QoS > General > QoS Properties**.

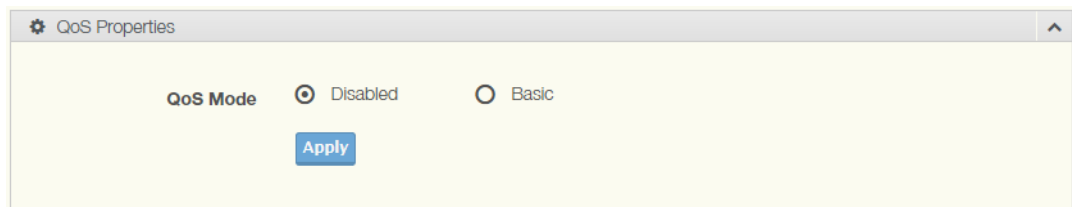

Figure 4.149 QoS > General > QoS Properties

The following table describes the items in the previous figure.

Item	Description
QoS Mode	Select Disabled or Basic to setup the QoS function.
Apply	Click Apply to save the values and update the screen.

The ensuing table for **QoS Global Information** settings are informational only: QoS Mode.

4.8.1.2 QoS Settings

Once the QoS function is enabled, you can configure the available settings.

To access this page, click **QoS > General > QoS Settings**.

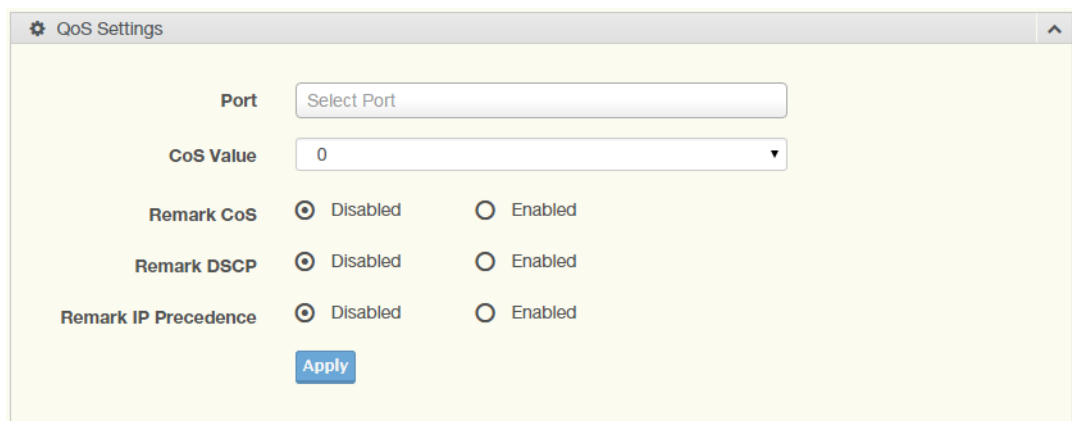

Figure 4.150 QoS > General > QoS Settings

The following table describes the items in the previous figure.

Item	Description
Port	Enter the port number to associate with the QoS setting.
CoS Value	Click the drop-down menu to designate the Class of Service (CoS) value (0 to 7) for the Port entry.
Remark CoS	Click Disabled or Enabled to setup the Remark CoS function. When enabled the LAN (preassigned priority values) is marked at Layer 2 boundary to CoS values.
Remark DSCP	Click Disabled or Enabled to setup the DSCP remark option for the QoS function.
Remark IP Precedence	Click Disabled or Enabled to setup the Remark IP Precedence for the QoS function.
Apply	Click Apply to save the values and update the screen.

To access this page, click **QoS > General > QoS Status**.

The following figure displays the **QoS Status** settings.

Port	CoS Value	Remark CoS	Remark DSCP	Remark IP Precedence
GE1	0	Disabled	Disabled	Disabled
GE2	0	Disabled	Disabled	Disabled
GE3	0	Disabled	Disabled	Disabled
GE4	0	Disabled	Disabled	Disabled
GE5	0	Disabled	Disabled	Disabled
GE6	0	Disabled	Disabled	Disabled
GE7	0	Disabled	Disabled	Disabled
GE8	0	Disabled	Disabled	Disabled

Figure 4.151 QoS > General > QoS Status

4.8.1.3 Queue Scheduling

The switch support eight CoS queues for each egress port. For each of the eight queues, two types of scheduling can be configured: Strict Priority and Weighted Round Robin (WRR).

Strict Priority scheduling is based on the priority of queues. Packets in a high-priority queue are always sent first and packets in a low-priority queue are only sent after all the high priority queues are empty.

Weighted RoundRobin (WRR) scheduling is based on the user priority specification to indicate the importance (weight) of the queue relative to the other CoS queues. WRR scheduling prevents low-priority queues from being completely ignored during periods of high priority traffic. The WRR scheduler sends some packets from each queue in turn.

To access this page, click **QoS > General > QoS Scheduling**.

Queue	Strict	WRR	Weight	% of WRR Bandwidth
1	<input checked="" type="radio"/>	<input type="radio"/>	1	
2	<input checked="" type="radio"/>	<input type="radio"/>	2	
3	<input checked="" type="radio"/>	<input type="radio"/>	3	
4	<input checked="" type="radio"/>	<input type="radio"/>	4	
5	<input checked="" type="radio"/>	<input type="radio"/>	5	
6	<input checked="" type="radio"/>	<input type="radio"/>	9	
7	<input checked="" type="radio"/>	<input type="radio"/>	13	
8	<input checked="" type="radio"/>	<input type="radio"/>	15	

Apply

Figure 4.152 QoS > General > QoS Scheduling

The following table describes the items in the previous figure.

Item	Description
Queue	Queue entry for egress port.
Strict	Select Strict to assign the scheduling designation to the selected queue.
WRR	Select WRR to assign the scheduling designation to the selected queue.
Weight	Enter a queue priority (weight) relative to the defined entries (WRR only).
% of WRR Bandwidth	Displays the allotted bandwidth for the queue entry in percentage values.
Apply	Click Apply to save the values and update the screen.

To access this page, click **QoS > General > QoS Information**.

The following figure displays the **Queue Information** settings.

Information Name	Information Value
Strict Priority Queue Number	8

Figure 4.153 QoS > General > QoS Information

4.8.1.4 CoS Mapping

The CoS Mapping allows you to apply CoS mapping.

To access this page, click **QoS > General > CoS Mapping**.

CoS Mapping

CoS to Queue Mapping

Class of Service	Queue	Class of Service	Queue
0	2	1	1
2	3	3	4
4	5	5	6
6	7	7	8

Queue to CoS Mapping

Queue	Class of Service	Queue	Class of Service
1	1	2	0
3	2	4	3
5	4	6	5
7	6	8	7

Apply

Figure 4.154 QoS > General > CoS Mapping

The following table describes the items in the previous figure.

Item	Description
CoS to Queue Mapping	
Class of Service	Displays the CoS for the queue entry.
Queue	Click the drop-down menu to select the queue priority for selected CoS.
Queue to CoS Mapping	
Queue	Displays the queue entry for CoS mapping.
Class of Service	Click the drop-down menu to select the CoS type
Apply	Click Apply to save the values and update the screen.

To access this page, click **QoS > General > CoS Mapping**.

The following figure displays the **CoS Mapping Information** settings.

Information Name	Information Value
Strict Priority Queue Number	8

Figure 4.155 QoS > General > CoS Mapping

To access this page, click **QoS > General > CoS Mapping**.

The following figure displays the **Queue Mapping Information** settings.

Queue	Mapping to CoS
1	1
2	0
3	2
4	3
5	4
6	5

Figure 4.156 QoS > General > CoS Mapping

4.8.1.5 DSCP Mapping

The DSCP to Queue mapping function maps queue values in incoming packets to a DSCP value that QoS uses internally to represent the priority of the traffic. The following table shows the DSCP to Queue map.

If these values are not appropriate for your network, you need to modify them. To access this page, click **QoS > General > DSCP Mapping**.

Figure 4.157 QoS > General > DSCP Mapping

The following table describes the items in the previous figure.

Item	Description
DSCP to Queue Mapping	
DSCP	Enter the DSCP entry to define the precedence values.
Queue	Click the drop-down menu to select the queue designation for the DSCP value.
Queue to DSCP Mapping	
Queue	Displays the queue value for the DSCP map.
DSCP	Enter the DSCP entry to define the precedence values.
Apply	Click Apply to save the values and update the screen.

The ensuing table for **DSCP Mapping Information** settings are informational only: DSCP and Mapping to Queue.

The ensuing table for **Queue Mapping Information** settings are informational only: Queue and Mapping to DSCP.

4.8.1.6 IP Precedence Mapping

The IP Precedence Mapping allows you to set IP Precedence mapping. To access this page, click **QoS > General > IP Precedence Mapping**.

The screenshot shows the 'IP Precedence Mapping' configuration page. It is divided into two main sections:

- IP Precedence to Queue Mapping:** This section contains two columns. The left column lists IP Precedence values from 0 to 7, and the right column lists Queue values from 1 to 8. Each IP Precedence value is paired with a dropdown menu showing the selected Queue value.
- Queue to IP Precedence Mapping:** This section contains two columns. The left column lists Queue values from 1 to 8, and the right column lists IP Precedence values from 0 to 7. Each Queue value is paired with a dropdown menu showing the selected IP Precedence value.

An 'Apply' button is located at the bottom center of the page.

Figure 4.158 QoS > General > IP Precedence Mapping

The following table describes the items in the previous figure.

Item	Description
IP Precedence to Queue Mapping	
IP Precedence	Displays the IP precedence value for the queue map.
Queue	Click the drop-down menu to map a queue value to the selected IP precedence.
Queue to IP Precedence Mapping	
Queue	Displays the queue entry for mapping IP precedence values.
IP Precedence	Click the drop-down menu to map an IP precedence value to the selected queue.
Apply	Click Apply to save the values and update the screen.

The ensuing table for **IP Precedence Mapping Information** settings are informational only: IP Precedence and Mapping to Queue.

The ensuing table for **Queue Mapping Information** settings are informational only: Queue and Mapping to IP Precedence.

4.8.2 QoS Basic Mode

Quality of Service (QoS) allows to give preferential treatment to certain types of traffic at the expense of others. Without QoS, the switch offers best-effort service to each packet, regardless of the packet contents or size sending the packets without any assurance of reliability, delay bounds, or throughput.

QoS mode supports two modes: 802.1p and DSCP.

4.8.2.1 Global Settings

The Global Settings page allows you to configure the trust mode to a port selection. To access this page, click **QoS > QoS Basic Mode > Global Settings**. The function is only available when **QoS Properties** is set to **Basic**.



Figure 4.159 QoS > QoS Basic Mode > Global Settings

The following table describes the items in the previous figure.

Item	Description
Trust Mode	Click the drop-down menu to select the trust state of the QoS basic mode. Settings: None, CoS/802.1p, DSCP, CoS/802.1p-DSCP and IP Precedence.
Apply	Click Apply to save the values and update the screen.

To access this page, click **QoS > General > Global Settings**.

The following figure displays the **QoS Information** settings.

Information Name	Information Value
Trust Mode	CoS/802.1p

Figure 4.160 QoS > General > Global Settings

4.8.2.2 Port Settings

The Port Settings page allows you to define a trust state (enabled or disabled) to a listed port.

To access this page, click **QoS > QoS Basic Mode > Port Settings**.

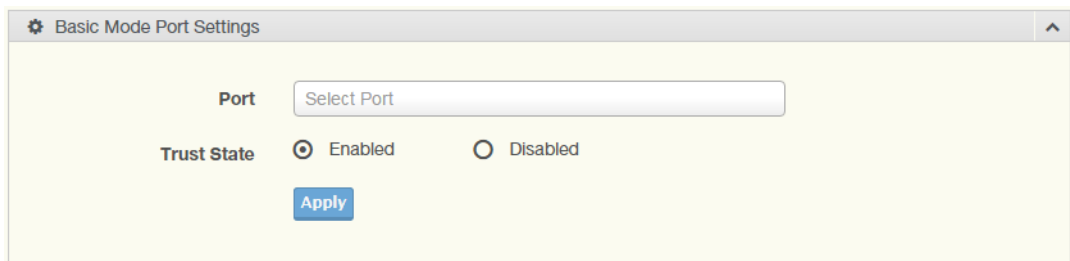

Figure 4.161 QoS > QoS Basic Mode > Port Settings

The following table describes the items in the previous figure.

Item	Description
Port	Enter the port number for the QoS basic mode setting.
Trust State	Select Enabled or Disabled to set the port's trust state status.
Apply	Click Apply to save the values and update the screen.

The ensuing table for **QoS Port Status** settings are informational only: Port and Trust State.

4.8.3 Rate Limit

Rate Limits features control on a per port basis. Bandwidth control is supported for the following: Ingress Bandwidth Control, Egress Bandwidth Control and Egress Queue.

4.8.3.1 Ingress Bandwidth Control

The Ingress Bandwidth Control page allows you to configure the bandwidth control for a listed port.

To access this page, click **QoS > Rate Limit > Ingress Bandwidth Control**.

Figure 4.162 QoS > Rate Limit > Ingress Bandwidth Control

The following table describes the items in the previous figure.

Item	Description
Port	Enter the port number for the rate limit setup.
State	Select Disabled or Enabled to set the port's state status.
Rate (Kbps)	Enter the value in Kbps (16 to 1000000) to set as the bandwidth rate for the selected port.
Action	Select the Ingress port action to be Drop or Shutdown.
Apply	Click Apply to save the values and update the screen.

To access this page, click **QoS > Rate Limit > Ingress Bandwidth Control**.

The following figure displays the **Ingress Bandwidth Control Recover Time** settings.

Figure 4.163 QoS > Rate Limit > Ingress Bandwidth Control

To access this page, click **QoS > Rate Limit > Ingress Bandwidth Control**.

The following figure displays the **Ingress Bandwidth Control Status** settings.

Port	Ingress RateLimit (Kbps)	Action
GE1	Off	Drop
GE2	Off	Drop
GE3	Off	Drop
GE4	Off	Drop
GE5	Off	Drop
GE6	Off	Drop

Figure 4.164 QoS > Rate Limit > Ingress Bandwidth Control

4.8.3.2 Egress Bandwidth Control

The Egress Bandwidth Control page allows you to set the egress bandwidth control for a listed port.

To access this page, click **QoS > Rate Limit > Egress Bandwidth Control**.

Figure 4.165 QoS > Rate Limit > Egress Bandwidth Control

The following table describes the items in the previous figure.

Item	Description
Port	Enter the port number to set the Egress Bandwidth Control.
State	Select Disabled or Enabled to set the Egress Bandwidth Control state.
Rate (Kbps)	Enter the value in Kbps (16 to 1000000) to set the Egress Bandwidth rate.
Apply	Click Apply to save the values and update the screen.

To access this page, click **QoS > Rate Limit > Egress Bandwidth Control**.

The following figure displays the **Egress Bandwidth Control Status** settings.

Port	Egress RateLimit (Kbps)
GE1	Off
GE2	Off
GE3	Off
GE4	Off
GE5	Off

Figure 4.166 QoS > Rate Limit > Egress Bandwidth Control

4.8.3.3 Egress Queue

The Egress Queue page allows you to set the egress bandwidth parameters.

To access this page, click **QoS > Rate Limit > Egress Queue**.

Figure 4.167 QoS > Rate Limit > Egress Queue

The following table describes the items in the previous figure.

Item	Description
Port	Click the drop-down menu to select the port to define the Egress queue.
Queue	Click the drop-down menu to set the queue order for the Egress setting.
State	Click Disabled or Enabled to set the Egress queue state.
CIR (Kbps)	Enter the value in Kbps (16 to 1000000) to set the CIR rate for the Egress queue.
Apply	Click Apply to save the values and update the screen.

The ensuing table for **FE1 Egress Per Queue Status** settings are informational only: Queue Id and Egress Rate Limit (Kbps).

4.8.4 Bandwidth Guarantee

4.8.4.1 Global Settings

To access this page, click **QoS > Bandwidth Guarantee > Global Settings**.

The screenshot shows the 'Global Settings' configuration page. At the top, there is a 'Status' section with two radio buttons: 'Disabled' (selected) and 'Enabled'. Below this is the 'Guarantee Bandwidth' section, featuring a text input field with the value '0' and a range indicator '(1-900) Mbps'. The 'Type' section has two radio buttons: 'UDP Source Port' (selected) and 'RTP H.264'. The 'UDP Source Port' section has a text input field with the value '0' and a range indicator '(1-65535)'. The 'Force Mode' section contains an unchecked checkbox. At the bottom center, there is a blue 'Apply' button.

Figure 4.168 QoS > Bandwidth Guarantee > Global Settings

The following table describes the items in the previous figure.

Item	Description
Status	Click Disabled or Enabled to set the guarantee bandwidth.
Guarantee Bandwidth	Enter the value for the guarantee bandwidth.
Type	Click UDP Source Port or RTP H.264 to set the guarantee bandwidth type.
UDP Source Port	Enter the port number for the UDP source.
Force Mode	Click the check box to enable the force mode.
Apply	Click Apply to save the values and update the screen.

To access this page, click **QoS > Bandwidth Guarantee > Global Settings**.

The following figure displays the **Ingress Bandwidth Control Status** settings.

Bandwidth Guarantee Information	
Information Name	Information Value
Status	Disabled
Guarantee Bandwidth	0 Mbps
Guarantee Type	UDP Source Port
UDP Source Port	0
Force Mode	Disabled

Figure 4.169 QoS > Bandwidth Guarantee > Global Settings

4.8.4.2 Utilization

To access this page, click **QoS > Bandwidth Guarantee > Utilization**.

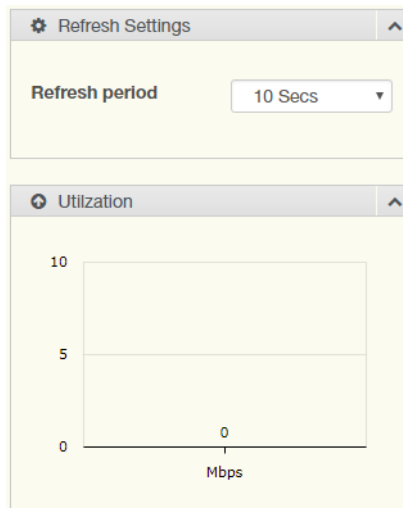

Figure 4.170 QoS > Bandwidth Guarantee > Utilization

The following table describes the items in the previous figure.

Item	Description
Refresh period	Click the drop-down menu to select refresh time.
Apply	Click Apply to save the values and update the screen.

4.9 Management

4.9.1 LLDP

LLDP is a one-way protocol without request/response sequences. Information is advertised by stations implementing the transmit function, and is received and processed by stations implementing the receive function.

4.9.1.1 LLDP System Settings

The LLDP System Settings allows you to configure the status (enabled or disabled) for the protocol, set the interval for frame transmission, set the hold time multiplier and the re-initialization delay.

To access this page, click **Management > LLDP > LLDP System Settings**.

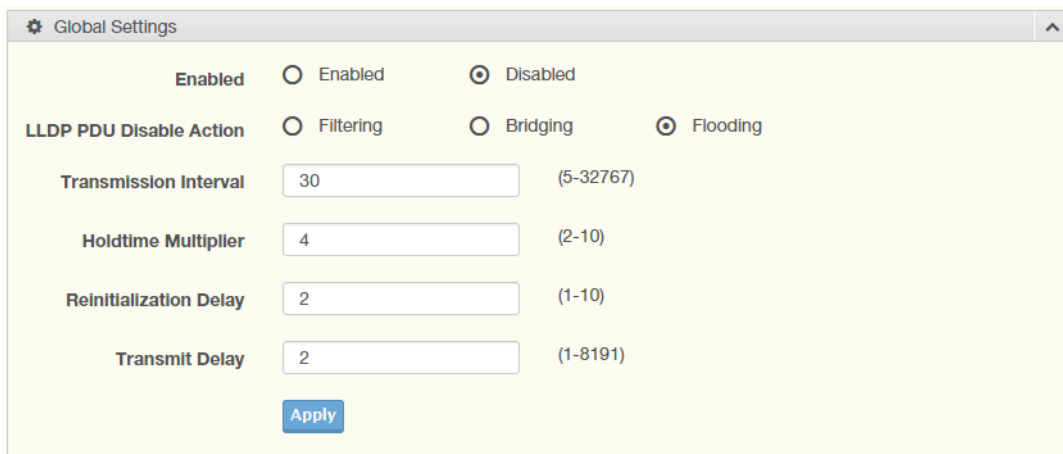

Figure 4.171 Management > LLDP > LLDP System Settings

The following table describes the items in the previous figure.

Item	Description
Enabled	Click Enabled or Disabled to set the Global Settings state.
LLDP PDU Disable Action	Click to select the LLDP PDU handling action when LLDP is globally disabled. Options include: Filtered, Bridged, or Flooded.
Transmission Interval	Select the interval at which frames are transmitted. The default is 30 seconds, and the valid range is 5 to 32768 seconds.
Holdtime Multiplier	Select the multiplier on the transmit interval to assign to TTL.
Reinitialization Delay	Select the delay length before re-initialization.
Transmit Delay	Select the delay after an LLDP frame is sent.
Apply	Click Apply to save the values and update the screen.

To access this page, click **Management > LLDP > LLDP System Settings**.

The following figure displays the **LLDP Global Config** settings.

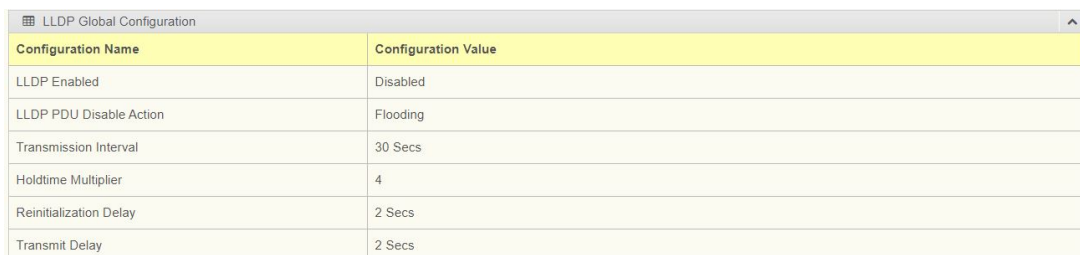

Configuration Name	Configuration Value
LLDP Enabled	Disabled
LLDP PDU Disable Action	Flooding
Transmission Interval	30 Secs
Holdtime Multiplier	4
Reinitialization Delay	2 Secs
Transmit Delay	2 Secs

Figure 4.172 Management > LLDP > LLDP System Settings

4.9.1.2 LLDP Port Settings

The LLDP Port Settings page allows you to configure the state (enabled or disabled) of the selected port.

To access this page, click **Management > LLDP > LLDP Port Settings**.



Figure 4.173 Management > LLDP > LLDP Port Settings > LLDP Port Configuration

The following table describes the items in the previous figure.

Item	Description
Port Select	Enter the port number associated with the LLDP setting.
State	Click the drop-down menu to select the LLDP port state.
Apply	Click Apply to save the values and update the screen.

The following figure displays the **Optional TLVs Selection** settings.

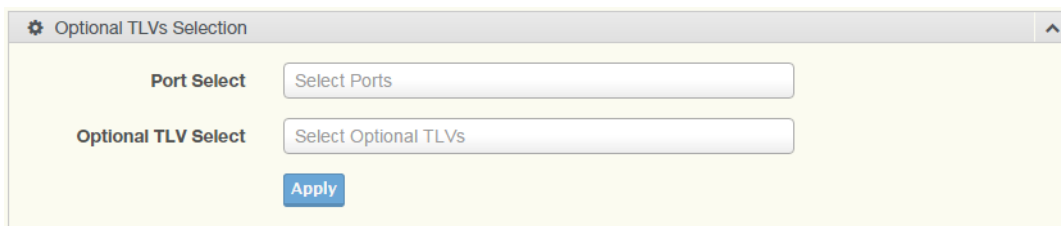

Figure 4.174 Management > LLDP > LLDP Port Settings > Optional TLVs Selection

The following table describes the items in the previous figure.

Item	Description
Port Select	Enter the port number associated with the TLV (optional) selection.

Item	Description
Optional TLV Select	Click the drop-down menu to select the LLDP optional TLVs to be carried (multiple selections are allowed). <ul style="list-style-type: none"> ■ System Name: To include system name TLV in LLDP frames. ■ Port Description: To include port description TLV in LLDP frames. ■ System Description: To include system description TLV in LLDP frames. ■ System Capability: To include system capability TLV in LLDP frames. ■ 802.3 MAC-PHY: To indicate the current duplex and bit rate settings of the device. ■ 802.3 Link Aggregation: To indicate the link can be aggregated. ■ 802.3 Maximum Frame Size: To indicate the maximum frame size capability of the MAC-PHY implementation. ■ Management Address: To select the advertising IP management address. ■ 802.1 PVID: To select to advertise the PVID in the TLV.
Apply	Click Apply to save the values and update the screen.

The following figure displays the **LLDP Port Status** settings.

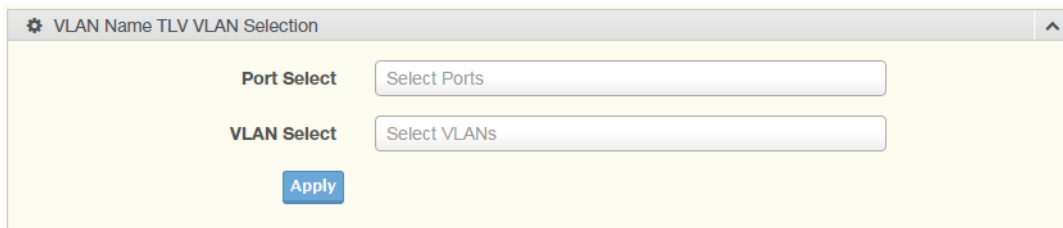

Figure 4.175 Management > LLDP > LLDP Port Settings > VLAN Name TLV VLAN Selection

The following table describes the items in the previous figure.

Item	Description
Port Select	Enter the port number to associated with the TLV selection.
VLAN Select	Select the VLAN Name ID to be carried out (multiple selection is allowed).
Apply	Click Apply to save the values and update the screen.

The ensuing table for **LLDP Port VLAN TLV Status** settings are informational only: Port and Selected VLAN.

4.9.1.3 LLDP Local Device Info

The LLDP Local Device Info page allows you to view information regarding network devices, providing that the switch has already obtained LLDP information on the devices.

To access this page, click **Management > LLDP > LLDP Local Device Info**.

The following figure displays the **Local Device Summary** settings.

Information Name	Information Value
Chassis ID Subtype	MAC Address
Chassis ID	00:0B:AB:F8:9D:95
System Name	Switch
System Description	switch
Capabilities Supported	Bridge
Capabilities Enabled	Bridge
Port ID Subtype	Interface name

Figure 4.176 Management > LLDP > LLDP Local Device Info

To access this page, click **Management > LLDP > LLDP Local Device Info**.

The following figure displays the **Port Status** settings.

Detail	Port	Selected VLAN
<input type="radio"/>	GE1	TX & RX
<input type="radio"/>	GE2	TX & RX
<input type="radio"/>	GE3	TX & RX
<input type="radio"/>	GE4	TX & RX
<input type="radio"/>	GE5	TX & RX
<input type="radio"/>	GE6	TX & RX
<input type="radio"/>	GE7	TX & RX

Figure 4.177 Management > LLDP > LLDP Local Device Info

4.9.1.4 LLDP Remote Device Info

The LLDP Remote Device Info page allows you to view information about remote devices, LLDP information must be available on the switch.

To access this page, click **Management > LLDP > LLDP Remote Device Info**.

Sel	Local Port	Chassis ID Subtype	Chassis ID	Port ID Subtype	Port ID	System Name	Time to Live
-----	------------	--------------------	------------	-----------------	---------	-------------	--------------

Figure 4.178 Management > LLDP > LLDP Remote Device Info

The following table describes the items in the previous figure.

Item	Description
Detail	Click to display the device details.
Delete	Click to delete the selected devices.
Refresh	Click to refresh the remote device information list.

4.9.1.5 LLDP Overloading

To access this page, click **Management > LLDP > LLDP Overloading**.

The following figure displays the **LLDP Overloading** settings.

Port	Total (Bytes)	Left to Send (Bytes)	Status	Status			
				Mandatory TLVs	802.3 TLVs	Optional TLVs	802.1 TLVs
GE1	29	1459	Not Overloading	21(Transmitted)			8(Transmitted)
GE2	29	1459	Not Overloading	21(Transmitted)			8(Transmitted)
GE3	29	1459	Not Overloading	21(Transmitted)			8(Transmitted)
GE4	29	1459	Not Overloading	21(Transmitted)			8(Transmitted)
GE5	29	1459	Not Overloading	21(Transmitted)			8(Transmitted)
GE6	29	1459	Not Overloading	21(Transmitted)			8(Transmitted)
GE7	29	1459	Not Overloading	21(Transmitted)			8(Transmitted)
GE8	29	1459	Not Overloading	21(Transmitted)			8(Transmitted)

Figure 4.179 Management > LLDP > LLDP Overloading

4.9.2 SNMP

Simple Network Management Protocol (SNMP) is a protocol to facilitate the monitoring and exchange of management information between network devices. Through SNMP, the health of the network or status of a particular device can be determined.

4.9.2.1 SNMP Settings

The SNMP Settings page allows you to set the SNMP daemon state (enabled or disabled).

To access this page, click **Management > SNMP > SNMP Settings**.

Figure 4.180 Management > SNMP > SNMP Settings

The following table describes the items in the previous figure.

Item	Description
State	Click Enabled or Disabled to define the SNMP daemon.
Apply	Click Apply to save the values and update the screen.

The ensuing table for **SNMP Information** settings are informational only: SNMP.

4.9.2.2 SNMP Community

The SNMP Community page provides configuration options for the community.

SNMP v1 and SNMP v2c use the group name (Community Name) certification. It's role is similar to the password function. If SNMP v1 and SNMP v2c are used, you can go directly from the configuration settings to this page to configure the SNMP community.

To access this page, click **Management > SNMP > SNMP Community**.

Figure 4.181 Management > SNMP > SNMP Community

The following table describes the items in the previous figure.

Item	Description
Community Name	Enter a community name (up to 20 characters).
Access Right	Click the radio box to specify the access level (read only or read write)
Apply	Click Apply to save the values and update the screen.

To access this page, click **Management > SNMP > SNMP Community**.

The following figure displays the **Community Status** settings.

No.	Community Name	Access Right	Action
1	public	read-only	Delete
2	private	read-write	Delete

Figure 4.182 Management > SNMP > SNMP Community

4.9.2.3 SNMPv3 EngineID

To access this page, click **Management > SNMP > SNMPv3 EngineID**.

Figure 4.183 Management > SNMP > SNMPv3 EngineID

The following table describes the items in the previous figure.

Item	Description
SNMP EngineID	Enter the hexadecimal string to define the engine ID for SNMPv3 agent.

4.9.2.4 SNMPv3 Settings

The SNMPv3 Settings page allows you to create SNMP groups. The users have the same level of security and access control permissions as defined by the group settings.

To access this page, click **Management > SNMP > SNMPv3 Settings**.

The screenshot shows a web form titled "User Settings" with the following elements:

- User Name:** A text input field with the placeholder "Input user name".
- Access Right:** Two radio buttons, "read-only" (selected) and "read-write".
- Encrypted:** An unchecked checkbox.
- Auth-Protocol:** A dropdown menu currently set to "None".
- Password:** A text input field with the placeholder "Input password".
- Priv-Protocol:** A dropdown menu currently set to "None".
- Password:** A second text input field with the placeholder "Input password".
- Add:** A blue button at the bottom of the form.

Figure 4.184 Management > SNMP > SNMPv3 Settings

The following table describes the items in the previous figure.

Item	Description
User Name	Enter a user name (up to 32 characters) to create an SNMP profile.
Access Right	Click read-only or read-write to define the access right for the profile.
Encrypted	Click the option to set the encrypted option for the user setting.
Auth-Protocol	Click the drop-down menu to select the authentication level: MD5 or SHA. The field requires a user password. <ul style="list-style-type: none"> ■ MD5: specify HMAC-MD5-96 authentication level ■ SHA: specify HMAC-SHA authentication protocol
Password	Enter the characters to define the password associated with the authentication protocol.
Priv-Protocol	Click the drop-down menu to select an authorization protocol: none or DES. The field requires a user password. <ul style="list-style-type: none"> ■ None: no authorization protocol in use ■ DES: specify 56-bit encryption in use
Password	Enter the characters to define the password associated with the authorization protocol.
Add	Click Add to save the values and update the screen.

The ensuing table for **User Status** settings are informational only: User Name, Access Right, Auth-Protocol, Priv-Protocol and **Delete** (click to delete the desired user name).

4.9.2.5 SNMP Trap

The SNMP Trap page allows you to set the IP address of the node and the SNMP credentials corresponding to the version that is included in the trap message.

To access this page, click **Management > SNMP > SNMP Trap**.

Figure 4.185 Management > SNMP > SNMP Trap

The following table describes the items in the previous figure.

Item	Description
IP Address	Enter the IP address to designate the SNMP trap host.
Community Name/ User Name	Click the drop-down menu to select a defined community name.
Version	Click the drop-down menu to designate the SNMP version credentials (v1, v2c - trap, v2c - inform, v2c - trap or v2c - inform).
Add	Click Add to save the values and update the screen.

The ensuing table for **Trap Host Status** settings are informational only: No., IP Address, Community Name, Version and **Delete** (click to delete the desired IP address).

4.9.3 Power Over Ethernet

Power Over Ethernet is the function supplying power to Powered Devices (PD) through the switch in the event that AC power is not readily available.

Power over Ethernet can be used for the following areas:

- Surveillance devices
- I/O sensors for security requirements
- Wireless access points

Series	Supported Models
EKI	EKI-7708E/G-4FP, EKI-7710E/G-2CP, EKI-7712E/G-4FP, EKI-7720G-4FP, EKI-7428G-4CP

4.9.3.1 PoE System Settings

The PoE System Settings page allows you to configure the overload disconnect and the maximum available wattage.

To access this page, click **Management > Power Over Ethernet > PoE System Settings**.

Figure 4.186 Management > Power Over Ethernet > PoE System Settings

The following table describes the items in the previous figure.

Item	Description
Maximum Power Available	Select the value in Watts to set the maximum available power.
OverLoad Disconnect Mode	Click the drop-down menu to designate the overload mode: <input type="checkbox"/> Overload Port First: <input checked="" type="checkbox"/> Port-Based Priority:
Apply	Click Apply to save the values and update the screen.

The ensuing table for **PoE System Information** settings are informational only: Firmware Version, Maximum Power Available, Actual Power Consumption and Overload Disconnect Type.

4.9.3.2 PoE Port Settings

The PoE Port Settings page allows you to configure the port status, its power limitations, legacy mode status, and power limit settings.

To access this page, click **Management > Power Over Ethernet > PoE Port Settings**.

Figure 4.187 Management > Power Over Ethernet > PoE Port Settings

The following table describes the items in the previous figure.

Item	Description
Port	Click the drop-down menu to select a PoE port.
Enabled	Select Enabled or Disabled to designate the PoE port function by ports.

Item	Description
Power Limit From Classification	Select Enabled or Disabled to designate the power limit classification.
Legacy Mode	Select Enabled or Disabled to designate the legacy mode option for the port.
Priority	Click the drop-down menu to configure the power supply priority: Critical , Low , Medium or High . Default is Low .
Power Limit	Enter a number to set the port power current limitation to be given to the Powered Device (PD)
Apply	Click Apply to save the values and update the screen.

The ensuing table for **PoE Information** settings are informational only: Port, Enable State, Power Limit From Classification, Priority, Legacy and Power Limit (W).

4.9.3.3 PoE Port Status

To access this page, click **Management > Power Over Ethernet > PoE Port Status**.

The ensuing table for **PoE Port Status** settings are informational only: Port, Current (mA), Voltage (V), Power (W) and Temp. (°C).

4.9.4 TCP Modbus Settings

The TCP Modbus function allows for client-server communication between a switch module (server) and a device in the networking running MODBUS client software (client).

4.9.4.1 TCP Modbus Settings

The TCP Modbus Settings page allows you to configure the modbus function.

To access this page, click **Management > TCP Modbus Settings > TCP Modbus Settings**.

Figure 4.188 Management > TCP Modbus Settings > TCP Modbus Settings

The following table describes the items in the previous figure.

Item	Description
State	Click Disabled or Enabled to set the TCP Modbus state.
Time out	Enter the value (1 to 86400) to define the timeout period between transport time.
Apply	Click Apply to save the values and update the screen.

To access this page, click **Management > TCP Modbus Settings > TCP Modbus Settings**.

The following figure displays the **TCP Modbus Status** settings.

Information Name	Information Value
TCP Modbus Status	Disabled
TCP Modbus Times Out	3600

Figure 4.189 Management > TCP Modbus Settings > TCP Modbus Settings

4.9.5 DHCP Server

The Dynamic Host Configuration Protocol (DHCP) is a network protocol enabling a server to automatically assign an IP address to a computer from a defined range of numbers configured for a given network.

4.9.5.1 Status Settings

The Status Settings page allows you to configure the DHCP server mode (enabled or disabled).

To access this page, click **Management > DHCP Server > Status Settings**.

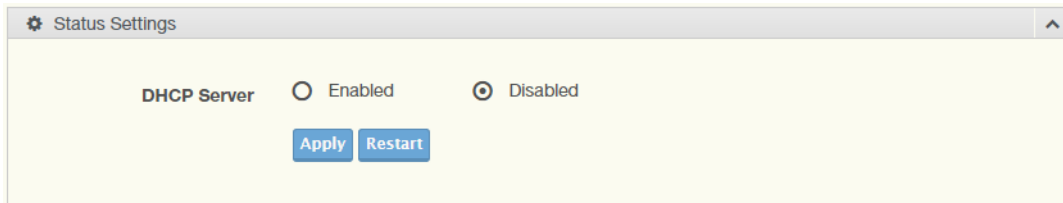

Figure 4.190 Management > DHCP Server > Status Settings

The following table describes the items in the previous figure.

Item	Description
DHCP Server	Select Enable or Disable to designate the DHCP server function type. When a new DHCP server mode is selected, the switch requires a system restart for the new mode to take effect.
Apply	Click Apply to save the values and update the screen.
Restart	Click Restart to have the switch perform a system restart function. In the event that the IP settings are changed, the DHCP server must be restarted for the IP settings to take effect.

The ensuing table for **Status Information** settings are informational only: DHCP Server Service.

4.9.5.2 Global Settings

The Global Settings page allows you to configure the global settings for the DHCP function.

To access this page, click **Management > DHCP Server > Global Settings**.

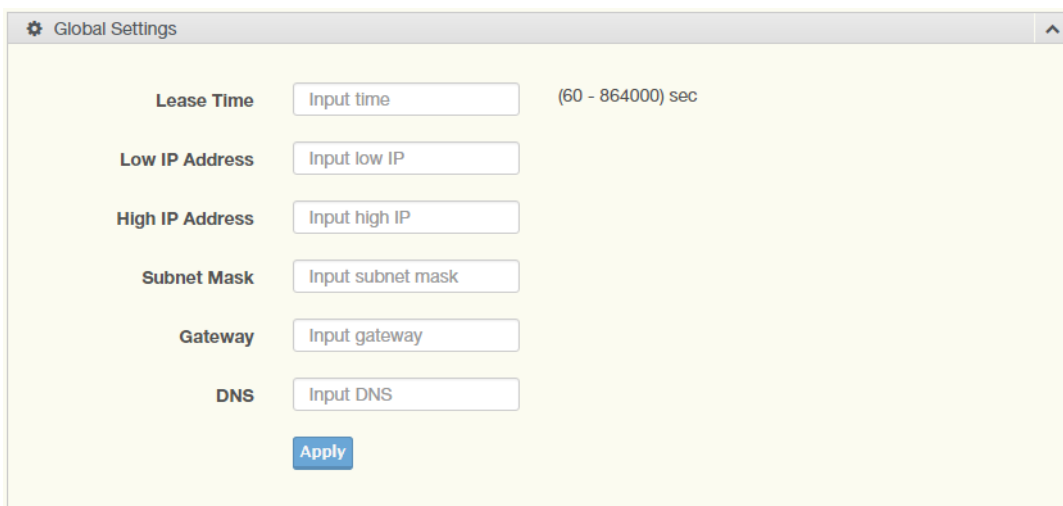

Figure 4.191 Management > DHCP Server > Global Settings

The following table describes the items in the previous figure.

Item	Description
Lease Time	Type in the value designating the lease time (60 - 864000) in seconds for each setting lease.
Low IP Address	Type in the value designating the lowest range in the IP address pool.
High IP Address	Type in the value designating the highest range in the IP address pool.
Subnet Mask	Type in the value designating the subnet mask for the IP address pool.
Gateway	Type in the value designating the gateway for the IP address pool.
DNS	Type in the value designating the DNS for the IP address pool.
Apply	Click Apply to save the values and update the screen.

To access this page, click **Management > DHCP Server > Global Settings**.

The following figure displays the **Global Information** settings.

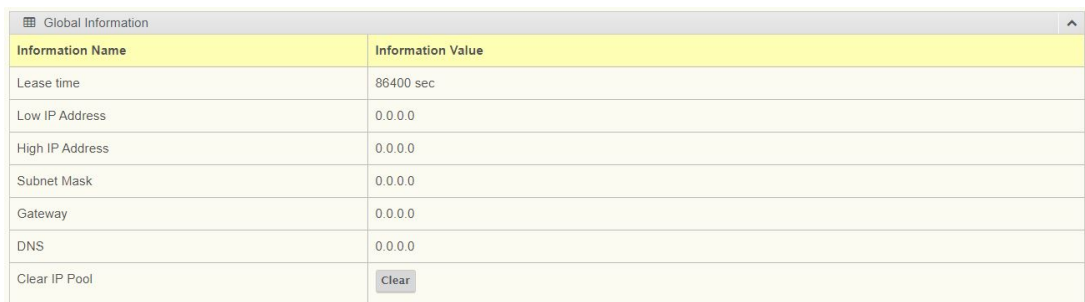

Information Name	Information Value
Lease time	86400 sec
Low IP Address	0.0.0.0
High IP Address	0.0.0.0
Subnet Mask	0.0.0.0
Gateway	0.0.0.0
DNS	0.0.0.0
Clear IP Pool	Clear

Figure 4.192 Management > DHCP Server > Global Settings

4.9.5.3 Port Settings

The Port Settings page allows you to configure selected ports for the DHCP function.

To access this page, click **Management > DHCP Server > Port Settings**.

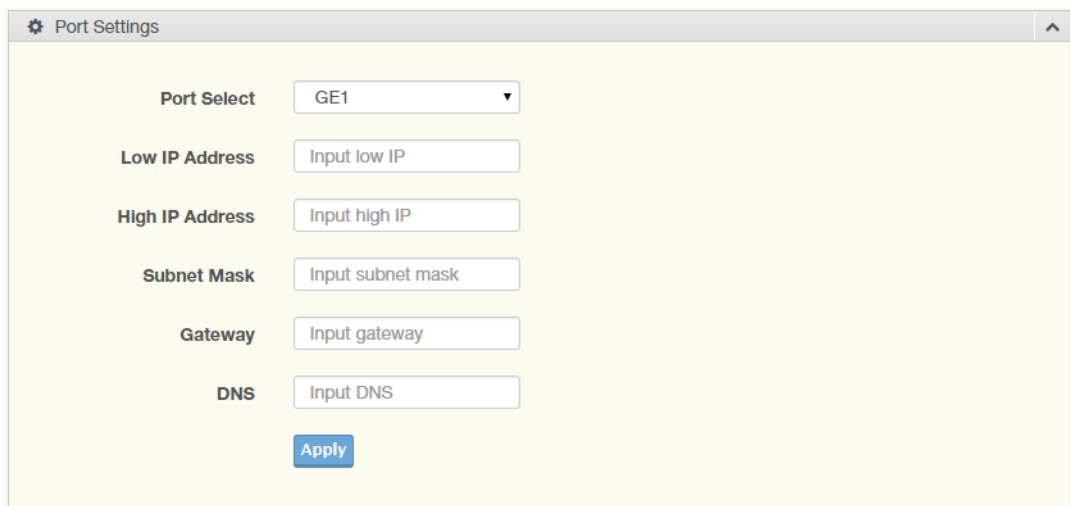

Figure 4.193 Management > DHCP Server > Port Settings

The following table describes the items in the previous figure.

Item	Description
Port Select	Click the drop-down menu to select a pre-defined port to configure. The sub options are designated for the selected port.
Low IP Address	Type in the value designating the lowest range in the IP address pool.

4.9.5.4 Option 82 Settings

The Option 82 Settings, also known as the DHCP relay agent information option, provide information about the network location of a DHCP client. In turn, the DHCP server uses the information to implement IP addresses or other parameters for the client.

To access this page, click **Management > DHCP Server > Option 82 Settings**.

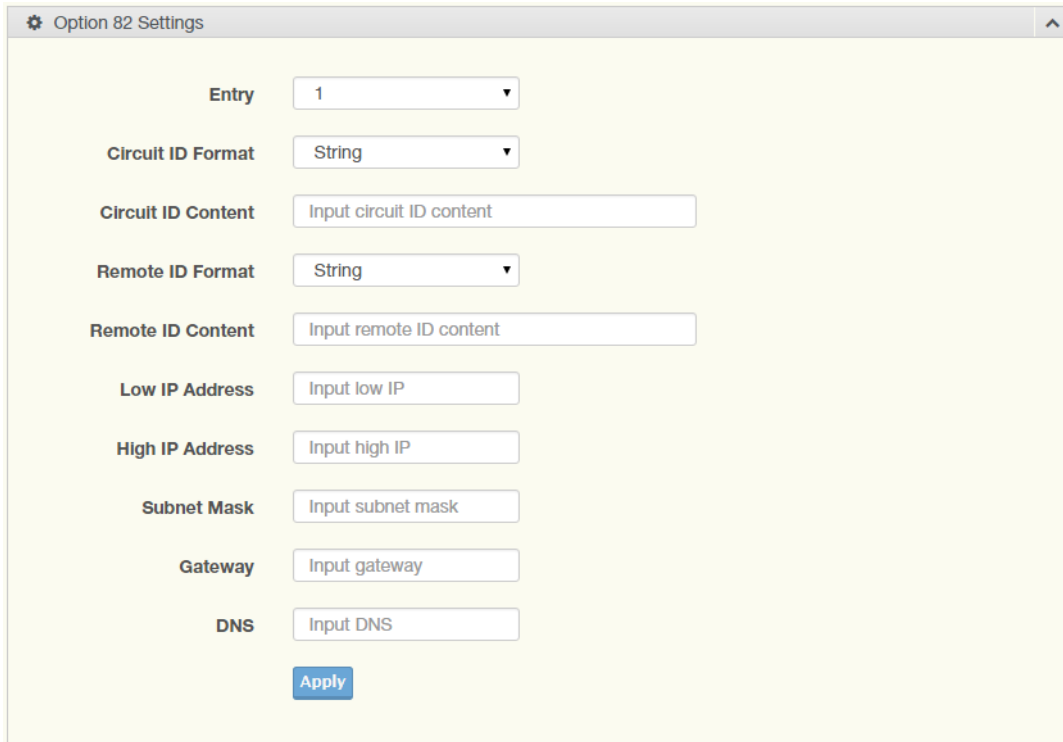

Figure 4.194 Management > DHCP Server > Option 82 Settings

The following table describes the items in the previous figure.

Item	Description
Entry	Click the drop-down menu to select an entry for the Option 82 setting.
Circuit ID Format	Click the drop-down menu to select the format of the circuit ID: string or hex.
Circuit ID Content	Enter the circuit ID string on the switch on which the request was received.
Remote ID Format	Click the drop-down menu to select the format of the remote ID: string or hex.
Remote ID Content	Enter the remote ID string of the host.
Low IP Address	Type in the value designating the lowest range in the IP address pool.
High IP Address	Type in the value designating the highest range in the IP address pool.
Subnet Mask	Type in the value designating the subnet mask for the IP address pool.
Gateway	Type in the value designating the gateway for the IP address pool.
DNS	Type in the value designating the DNS for the IP address pool.
Apply	Click Apply to save the values and update the screen.

To access this page, click **Management > DHCP Server > Option 82 Settings**.

The following figure displays the **Entry Information** settings.

Information Name	Information Value
Entry ID	1
Circuit ID Format	String
Circuit ID Content	
Remote ID Format	String
Remote ID Content	
Low IP Address	0.0.0.0
High IP Address	0.0.0.0
Subnet Mask	0.0.0.0
Gateway	0.0.0.0
DNS	0.0.0.0
Modify	<input type="button" value="Edit"/> <input type="button" value="Clear"/>

Figure 4.195 Management > DHCP Server > Option 82 Settings

4.9.5.5 Client MAC Settings

To access this page, click **Management > DHCP Server > Client MAC Settings**.

Client MAC Settings

Entry ID (1-100)

Client MAC Address

IP Address

Subnet Mask

Gateway

DNS

Figure 4.196 Management > DHCP Server > Client MAC Settings

The following table describes the items in the previous figure.

Item	Description
Entry ID	Type in the value designating the entry ID.
Client MAC Address	Enter the MAC address for DHCP server.
IP Address	Enter a value to specify the IP address of the interface.
Subnet Mask	Enter a value to specify the IP subnet mask for the interface.
Gateway	Enter a value to specify the gateway for the interface.
DNS	Enter a value to specify the DNS server for the interface.
Apply	Click Apply to save the values and update the screen.

The ensuing table for **Client MAC Information** settings are informational only: Entry ID, Client MAC Address, IP Address, Subnet Mask and Modify (Click **Detail** to display the detail information of desired entry id or **Delete** to delete the desired entry id).

4.9.5.6 Lease Entry

To access this page, click **Management > DHCP Server > Lease Entry**.

The following figure displays the **Lease entry Table** settings.

Client Mac	Start Time	End Time	Type

Figure 4.197 Management > DHCP Server > Lease Entry

4.9.6 SMTP Client

Simple Mail Transfer Protocol (SMTP) is a protocol to send e-mail messages between servers. SMTP is used to send messages from a mail client to a mail server. SMTP by default uses TCP port 25.

4.9.6.1 Global Settings

The Global Settings page allows you to set the active profile for the SMTP client. To access this page, click **Management > SMTP Client > Global Settings**.

Global Settings

Active Profile: None

Apply

Figure 4.198 Management > SMTP Client > Global Settings

The following table describes the items in the previous figure.

Item	Description
Active Profile	Click the drop-down menu to select the profile status (None, 1 or 2).
Apply	Click Apply to save the values and update the screen.

The ensuing table for **SMTP Information** settings are informational only: Active Profile Id.

4.9.6.2 Profile Settings

The Profile Settings page allows you to select the server IP, the server port, and sender mail for the listed profile.

To access this page, click **Management > SMTP Client > Profile Settings**.

Profile Settings

Profile ID: 1

Server IP: Input server IP

Server Port: 25

Sender Mail: Input mail address

Apply

Figure 4.199 Management > SMTP Client > Profile Settings > Profile Settings

The following table describes the items in the previous figure.

Item	Description
Profile ID	Click the drop-down menu to select the identification type for the profile (1 or 2).
Server IP	Enter the IP address to designate the server host.
Server Port	Enter the port number to designate the port associated with the server IP address.
Sender Mail	Enter the email address of the sender client.
Apply	Click Apply to save the values and update the screen.

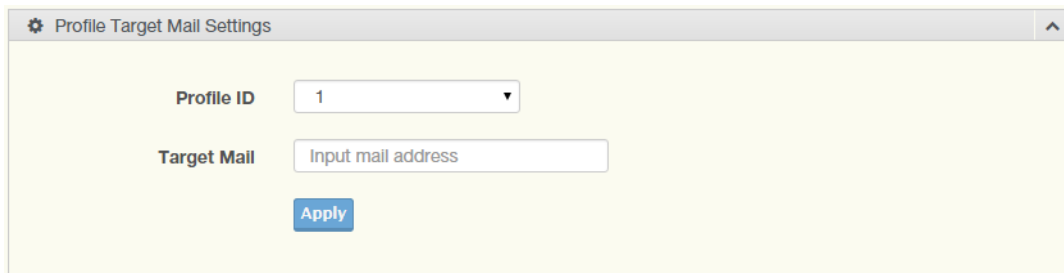

Figure 4.200 Management > SMTP Client > Profile Settings > Profile Target Mail Settings

The following table describes the items in the previous figure.

Item	Description
Profile ID	Click the drop-down menu to select the identification type for the profile (1 or 2).
Target Mail	Enter the email address of the target client.
Apply	Click Apply to save the values and update the screen.

To access this page, click **Management > SMTP Client > Profile Settings > Profile Target Mail Settings**.

The following figure displays the **Profile Information** settings.

Information Name	Information Value	Delete
Profile ID	1	
Server IP	0.0.0.0	
Server Port	25	
Sender Mail Address		

Figure 4.201 Management > DHCP Server > Lease Entry

4.9.6.3 Sending Message

The Sending Message page allows you to setup the log message for use with the SMTP client.

To access this page, click **Management > SMTP Client > Sending Message**.

Figure 4.202 Management > SMTP Client > Sending Message

The following table describes the items in the previous figure.

Item	Description
Title	Assign the title of the email. The maximum length is 20 characters (alphanumeric, symbols (. (dot), _ (underline), - (dash line) and space).
Content	Assign the content of the email. The maximum length is 64 characters (alphanumeric, symbols (. (dot), _ (underline), - (dash line) and space).
Apply	Click Apply to save the values and update the screen.

4.9.7 RMON

Remote monitoring (RMON) uses a client-server model to monitor/manage remote devices on a network.

4.9.7.1 RMON Statistics

The RMON Statistics page allows you to view information regarding packet sizes and information for physical layer errors. The information displayed is according to the RMON standard.

To access this page, click **Management > RMON > RMON Statistics**.

Figure 4.203 Management > RMON > RMON Statistics

The following table describes the items in the previous figure.

Item	Description
Index	Enter an entry selection (1 to 65535) to display its statistical information.
Port	Enter the respective port number for the selected entry.
Owner	Enter the name of the owner of the RMON group.
Apply	Click Apply to save the values and update the screen.

The ensuing table for **Statistics Information** settings are informational only: Index, Port, Drop Events, Octets, Packets, Broadcast, Multi-cast, Owner and **Delete** (click to delete the desired index).

4.9.7.2 RMON History

The RMON History page allows you to configure the display of history entries. To access this page, click **Management > RMON > RMON History**.

Figure 4.204 Management > RMON > RMON History

The following table describes the items in the previous figure.

Item	Description
Index	Enter the index entry (1 to 65535) to select the number of new history table entries.
Port	Select the specific port switch.
Buckets Requested	Enter the specific (1-50) number of samples to store.
Interval	Enter value in seconds (1 to 3600) to designate a specific interval time for the collection of samples.
Owner	Enter the name of the owner of the RMON history group.
Apply	Click Apply to save the values and update the screen.

The ensuing table for **History Information** settings are informational only: Index, Port, Buckets Requested, Interval, Owner and **Delete** (click to delete the desired index).

4.9.7.3 RMON Alarm

The RMON Alarm page allows you to configure RMON statistics group and alarm groups.

To access this page, click **Management > RMON > RMON Alarm**.

Figure 4.205 Management > RMON > RMON Alarm

The following table describes the items in the previous figure.

Item	Description
Index	Enter the index entry (1 to 65535) to define a specific Alarm Collection history entry.
Interval	Enter a value (1 to 2147483647) to define the interval value for the Alarm Collection history.
Variable	Enter the alarm variables to define the monitoring triggers.
Sample Type	Enter the variable sample type.
Rising Threshold	Enter the rising alarm threshold trigger.
Falling Threshold	Enter the falling alarm threshold trigger.
Rising Event Index	Enter the rising event index (1-65535) to define the alarm group.
Falling Event Index	Enter the falling event index (1-65535) to define the alarm group.
Owner	Enter the name of the owner of the RMON alarm group.
Apply	Click Apply to save the values and update the screen.

The ensuing table for **Alarm Information** settings are informational only: Index, Interval, Variable, Sample Type, Rising Threshold, Falling Threshold, Rising Event Index, Falling Event Index, Owner and **Delete** (click to delete the desired index).

4.9.7.4 RMON Event

The RMON Event page is used to configure RMON event groups.

To access this page, click **Management > RMON > RMON Event**.

Figure 4.206 Management > RMON > RMON Event

The following table describes the items in the previous figure.

Item	Description
Index	Enter the index entry (1 to 65535) to define a specific RMON event.
Description	Enter a value (1 to 2147483647) to define the interval value for the Alarm Collection history.
Type	Click the drop-down menu to define the event type: None, Log, SNMP Trap, Log and Trap.
Community	Enter the community string to be passed for the specified event.
Owner	Enter the name of the owner of the RMON event.
Apply	Click Apply to save the values and update the screen.

The ensuing table for **Event Information** settings are informational only: Index, Description, Type, Community, Owner and **Delete** (click to delete the desired index).

4.9.8 NTP Server

To access this page, click **Management > NTP Server**.

The screenshot shows the NTP Server configuration interface. At the top, there is a title bar with a gear icon and the text 'NTP Server'. Below the title bar, there are two rows of radio buttons. The first row is for 'NTP Server' with 'Disabled' selected. The second row is for 'Manual Time' with 'Disabled' selected. Below these are ten text input fields labeled 'Server Address 1' through 'Server Address 10', each containing the placeholder text 'Input server'. At the bottom center is a blue 'Apply' button.

Figure 4.207 Management > NTP Server

The following table describes the items in the previous figure.

Item	Description
NTP Server	Click the radio button to enable or disable the NTP server function.
Manual Time	Click the radio button to enable or disable the manual time function.
Server Address 1 ~ Server Address 10	Enter the address of the NTP server. This is a text string of up to 64 characters containing the encoded unicast IP address or hostname of a NTP server.
Apply	Click Apply to save the values and update the screen.

The ensuing table for **NTP Server Status** settings are informational only: INTP Server Status, Manual Time, Server AddressInformation Value, Server 1, Server 2, Server 3, Server 4, Server 5, Server 6, Server 7, Server 8, Server 9 and Server 10.

4.10 Diagnostics

Through the Diagnostics function configuration of settings for the switch diagnostics is available.

4.10.1 Cable Diagnostics

The Cable Diagnostics page allows you to select the port for applying a copper test. To access this page, click **Diagnostics > Cable Diagnostics**.

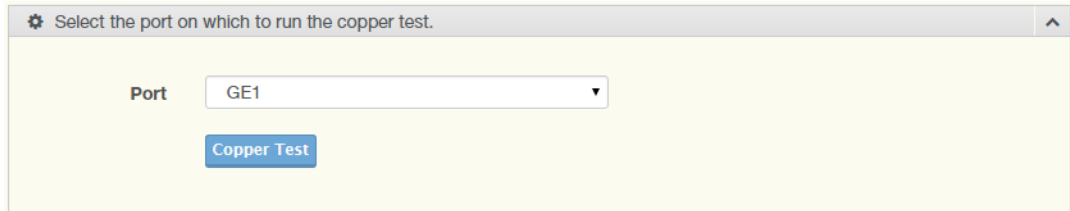

Figure 4.208 Diagnostics > Cable Diagnostics

The following table describes the items in the previous figure.

Item	Description
Port	Click the drop-down menu to select a pre-defined port for diagnostic testing. Giga ports are displayed with a channel A to D designation.
Copper Test	Click Copper Test to display the test result for the selected port.

The ensuing table for **Test Result** settings are informational only: Port, Channel A, Cable Length A, Channel B, Cable Length B, Channel C, Cable Length C, Channel D and Cable Length D.

4.10.2 Ping Test

The Ping Test page allows you to configure the test log page.

To access this page, click **Diagnostics > Ping Test**.

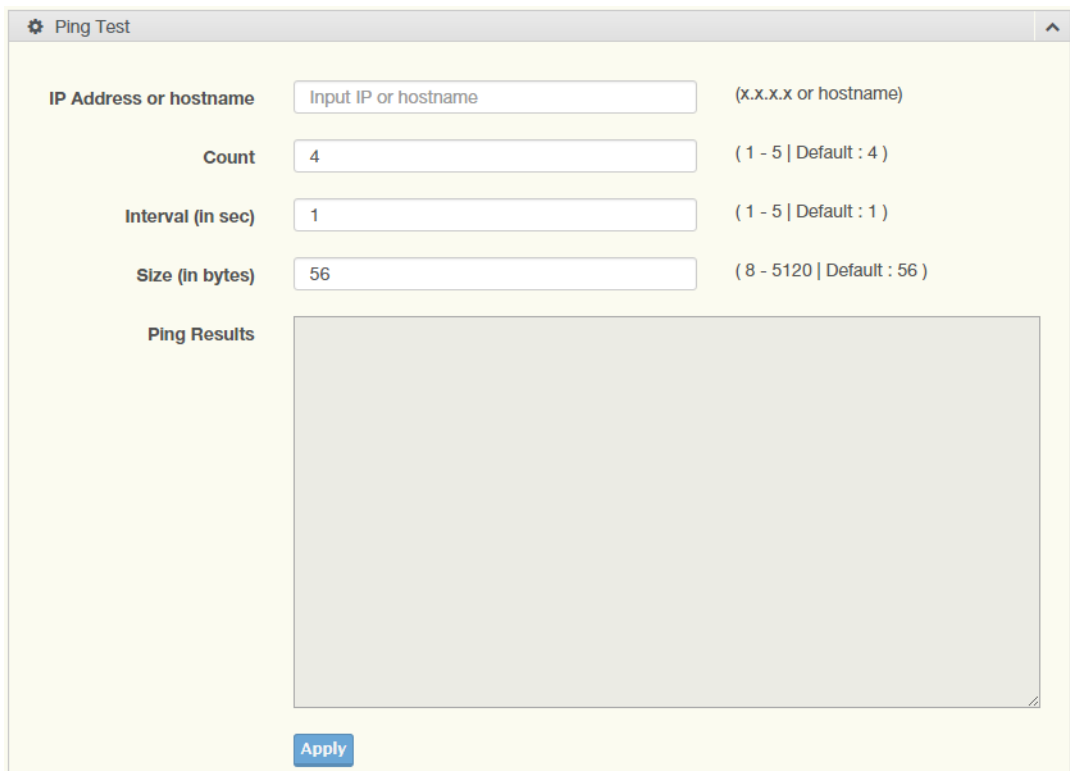

Figure 4.209 Diagnostics > Ping Test

The following table describes the items in the previous figure.

Item	Description
IP Address	Enter the IP address or host name of the station to ping. The initial value is blank. The IP Address or host name you enter is not retained across a power cycle. Host names are composed of series of labels concatenated with periods. Each label must be between 1 and 63 characters long, maximum of 64 characters.
Count	Enter the number of echo requests to send. The default value is 4. The value ranges from 1 to 5. The count entered is not retained across a power cycle.
Interval (in sec)	Enter the interval between ping packets in seconds. The default value is 1. The value ranges from 1 to 5. The interval entered is not retained across a power cycle.
Size (in bytes)	Enter the size of ping packet. The default value is 56. The value ranges from 8 to 5120. The size entered is not retained across a power cycle.
Ping Results	<p>Display the reply format of ping.</p> <p>PING 172.17.8.254 (172.17.8.254): 56 data bytes</p> <p>--- 172.17.8.254 ping statistics ---</p> <p>4 packets transmitted, 0 packets received, 100% packet loss</p> <p>Or</p> <p>PING 172.17.8.93 (172.17.8.93): 56 data bytes</p> <p>64 bytes from 172.17.8.93: icmp_seq=0 ttl=128 time=0.0 ms</p> <p>64 bytes from 172.17.8.93: icmp_seq=1 ttl=128 time=0.0 ms</p> <p>64 bytes from 172.17.8.93: icmp_seq=2 ttl=128 time=0.0 ms</p> <p>64 bytes from 172.17.8.93: icmp_seq=3 ttl=128 time=0.0 ms</p> <p>--- 172.17.8.93 ping statistics ---</p> <p>4 packets transmitted, 4 packets received, 0% packet loss</p> <p>round-trip min/avg/max = 0.0/0.0/0.0 ms</p>
Apply	Click Apply to display ping result for the IP address.

4.10.3 IPv6 Ping Test

The IPv6 Ping Test page allows you to configure the Ping Test for IPv6.

To access this page, click **Diagnostics > IPv6 Ping Test**.

Figure 4.210 Diagnostics > IPv6 Ping Test

The following table describes the items in the previous figure.

Item	Description
IPv6 Address	Enter the IP address or host name of the station you want the switch to ping. The initial value is blank. The IP Address or host name you enter is not retained across a power cycle. Host names are composed of series of labels concatenated with dots. Each label must be between 1 and 63 characters long, and the entire hostname has a maximum of 64 characters.
Count	Enter the number of echo requests you want to send. The default value is 4. The value ranges from 1 to 5. The count you enter is not retained across a power cycle.
Interval (in sec)	Enter the interval between ping packets in seconds. The default value is 1. The value ranges from 1 to 5. The interval you enter is not retained across a power cycle.
Size (in bytes)	Enter the size of ping packet. The default value is 56. The value ranges from 8 to 5120. The size you enter is not retained across a power cycle.

Item	Description
Ping Results	Display the reply format of ping. PING 2222::777 (2222::777): 56 data bytes --- 2222::777 ping statistics --- 4 packets transmitted, 0 packets received, 100% packet loss Or PING 2222::717 (2222::717): 56 data bytes 64 bytes from 2222::717: icmp6_seq=0 ttl=128 time=10.0 ms 64 bytes from 2222::717: icmp6_seq=1 ttl=128 time=0.0 ms 64 bytes from 2222::717: icmp6_seq=2 ttl=128 time=0.0 ms 64 bytes from 2222::717: icmp6_seq=3 ttl=128 time=0.0 ms --- 2222::717 ping statistics --- 4 packets transmitted, 4 packets received, 0% packet loss round-trip min/avg/max = 0.0/2.5/10.0 ms
Apply	Click Apply to display ping result for the IP address.

4.10.4 System Log

4.10.4.1 Logging Service

The Logging Service page allows you to setup the logging services feature for the system log.

To access this page, click **Diagnostics > System Log > Logging Service**.

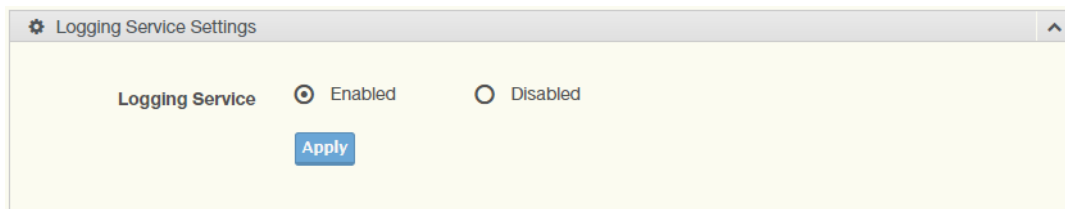

Figure 4.211 Diagnostics > System Log > Logging Service

The following table describes the items in the previous figure.

Item	Description
Logging Service	Click Enabled or Disabled to set the Logging Service status.
Apply	Click Apply to save the values and update the screen.

The ensuing table for **Logging Information** settings are informational only: Logging Service.

4.10.4.2 Local Logging

The Local Logging page allows you to designate a local target when the severity criteria is reached.

To access this page, click **Diagnostics > System Log > Local Logging**.

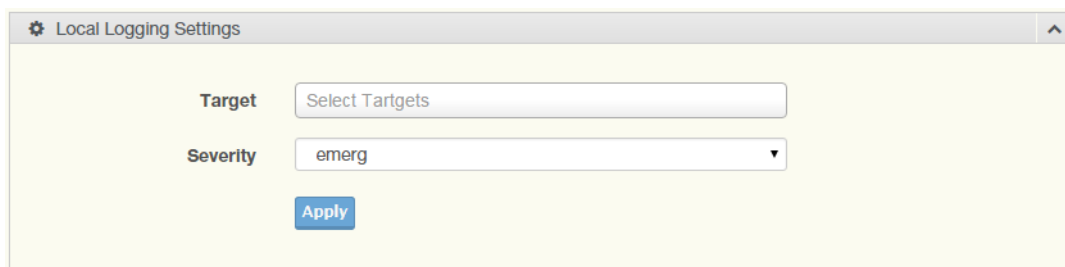

Figure 4.212 Diagnostics > System Log > Local Logging

The following table describes the items in the previous figure.

Item	Description
Target	Enter the local logging target.
Severity	<p>Click the drop-down menu to select the severity level for local log messages.</p> <p>The level options are:</p> <ul style="list-style-type: none"> ■ emerg: Indicates system is unusable. It is the highest level of severity ■ alert: Indicates action must be taken immediately ■ crit: Indicates critical conditions ■ error: Indicates error conditions ■ warning: Indicates warning conditions ■ notice: Indicates normal but significant conditions ■ info: Indicates informational messages ■ debug: Indicates debug-level messages
Apply	Click Apply to save the values and update the screen.

The ensuing table for **Local Logging Settings Status** settings are informational only: Status, Target, Severity and **Delete** (click to delete the desired target).

4.10.4.3 System Log Server

The System Log Server page allows you to configure the log server.

To access this page, click **Diagnostics > System Log > System Log Server**.

Figure 4.213 Diagnostics > System Log > System Log Server

The following table describes the items in the previous figure.

Item	Description
Server Address	Enter the IP address of the log server.
Server Port	Enter the Udp port number of the log server.

Item	Description
Severity	Click the drop-down menu to select the severity level for local log messages. The default is emerg. The level options are: <ul style="list-style-type: none"> ■ emerg: Indicates system is unusable. It is the highest level of severity ■ alert: Indicates action must be taken immediately ■ crit: Indicates critical conditions ■ error: Indicates error conditions ■ warning: Indicates warning conditions ■ notice: Indicates normal but significant conditions ■ info: Indicates informational messages ■ debug: Indicates debug-level messages
Facility	Click the drop-down menu to select facility to which the message refers.
Apply	Click Apply to save the values and update the screen.

The ensuing table for **Remote Logging Setting Status** settings are informational only: Status, Server Info, Severity, Facility and **Delete** (click to delete the desired server address).

4.10.5 DDM

The DDM page allows you to setup the diagnostic alarm status.
To access this page, click **Diagnostics > DDM**.



Figure 4.214 Diagnostics > DDM > Diagnostic Alarm Settings

The following table describes the items in the previous figure.

Item	Description
Diagnostic Alarm	Click the drop-down menu to designate the announcement method: Disabled, SysLog, E-mail, or SNMP.
Apply	Click Apply to save the values and update the screen.

The ensuing table for **Diagnostic Alarm Information** settings are informational only: Diagnostic Alarm.

GE17	High Alarm	High Warning	Low Alarm	Low Warning
Temperature 127°C ~ -127°C	95.000 °C <input type="radio"/> Enabled <input checked="" type="radio"/> Disabled	90.000 °C <input type="radio"/> Enabled <input checked="" type="radio"/> Disabled	-50.000 °C <input type="radio"/> Enabled <input checked="" type="radio"/> Disabled	-45.000 °C <input type="radio"/> Enabled <input checked="" type="radio"/> Disabled
Voltage 0.001~6V	3.500 V <input type="radio"/> Enabled <input checked="" type="radio"/> Disabled	3.450 V <input type="radio"/> Enabled <input checked="" type="radio"/> Disabled	3.100 V <input type="radio"/> Enabled <input checked="" type="radio"/> Disabled	3.150 V <input type="radio"/> Enabled <input checked="" type="radio"/> Disabled
TX Basis 1~131mA	100.000 mA <input type="radio"/> Enabled <input checked="" type="radio"/> Disabled	90.000 mA <input type="radio"/> Enabled <input checked="" type="radio"/> Disabled	6.000 mA <input type="radio"/> Enabled <input checked="" type="radio"/> Disabled	7.000 mA <input type="radio"/> Enabled <input checked="" type="radio"/> Disabled
TX Power 8~39dbm	-1.000 dbm <input type="radio"/> Enabled <input checked="" type="radio"/> Disabled	-5.000 dbm <input type="radio"/> Enabled <input checked="" type="radio"/> Disabled	-35.000 dbm <input type="radio"/> Enabled <input checked="" type="radio"/> Disabled	-30.000 dbm <input type="radio"/> Enabled <input checked="" type="radio"/> Disabled
RX Power 8~39dbm	-1.000 dbm <input type="radio"/> Enabled <input checked="" type="radio"/> Disabled	-5.000 dbm <input type="radio"/> Enabled <input checked="" type="radio"/> Disabled	-35.000 dbm <input type="radio"/> Enabled <input checked="" type="radio"/> Disabled	-30.000 dbm <input type="radio"/> Enabled <input checked="" type="radio"/> Disabled

Figure 4.215 Diagnostics > DDM > DMI INFO

The following table describes the items in the previous figure.

Item	Description
High Alarm	Click Enabled or Disabled to set the alarm state.
High Warning	Click Enabled or Disabled to set the alarm state.
Low Alarm	Click Enabled or Disabled to set the alarm state.
Low Warning	Click Enabled or Disabled to set the alarm state.
Apply	Click Apply to save the values and update the screen.

The ensuing table for **Vendor Info** settings are informational only: **Refresh** (click to reload the vendor information), Port, Connector, Speed, VendorName, VendorOui, VendorPn, VendorRev, VendorSn and DateCode.

4.10.6 LED Indication

To access this page, click **Diagnostics > LED Indication**.

Figure 4.216 Diagnostics > LED Indication

The following table describes the items in the previous figure.

Item	Description
LED	Click the drop-down menu to select LED indicator.
State	Select Enable or Disable to enable LED alarm.
Event	Click to select the event of LED alarm.
Apply	Click Apply to save the values and update the screen.

To access this page, click **Diagnostics > LED Indication**.

The following figure displays the **LED Information** settings.

LED Information	
LED	State
Alarm	Enabled

LED :

Event Information			
Event	State	Error Times	Delete
Power Failure	ERROR	1	<input type="button" value="Delete"/>

Event Detail	
Event	State
Power Failure	Power 1 is Fail.

Figure 4.217 Diagnostics > LED Indication

4.11 Tools

4.11.1 IXM

The IXM tool is an industrial Ethernet switch solution to help the users deploy industrial Ethernet switch hardware by allowing users with multiple, managed Ethernet switches in the field to eliminate the need to individually connect to each device to configure it.

To access this page, click **Tools > IXM**.

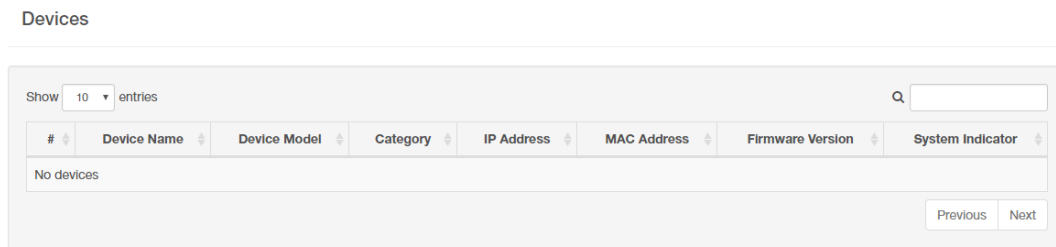

Figure 4.218 Tools > IXM

The following table describes the items in the previous figure.

Item	Description
Search Field	Enter criteria to search the IXM information.
#	Displays the reference to the device number.
Device Name	Displays the device name.
Device Model	Displays the device model type.
Category	Displays the device's category type.
IP Address	Displays the device's IP address.
MAC Address	Displays the device's IP MAC address.
Firmware Version	Displays the device's firmware version.
System Indicator	Displays the device's system indicator.
Previous	Click Previous to back to previous page.
Next	Click Next to go to next page.

4.11.2 Backup Manager

The Backup Manager page allows you to configure a remote TFTP sever or host file system in order to backup the firmware image or configuration file.

To access this page, click **Tools > Backup Manager**.

The screenshot shows the Backup Manager configuration interface. It includes a title bar 'Backup' with a gear icon and an up arrow. The main content area is light yellow. It contains four sections: 'Backup Method' with a dropdown menu set to 'TFTP'; 'Server IP' with a text input field containing 'Input IP' and a note '(IPv4 or IPv6 Address)'; 'Backup Type' with a list of radio buttons: 'Image' (selected), 'Running configuration', 'Startup configuration', 'Custom configuration', 'Flash log', and 'Buffered log'; and 'Image' with a list of radio buttons: 'EKI-7720G-4FI-AE-1-01-01.hex (Active)' (selected) and 'EKI-7720G-4FI-AE-1-00-97.hex (Backup)'. At the bottom is a blue 'Backup' button.

Figure 4.219 Tools > Backup Manager

The following table describes the items in the previous figure.

Item	Description
Backup Method	Click the drop-down menu to select the backup method: TFTP or HTTP.
Server IP	Enter the IP address of the backup server.
Backup Type	Click a type to define the backup method: image: running configuration, startup configuration, custom configuration, flash log, or buffered log.
Image	Click the format for the image type: Active or Backup.
Backup	Click Backup to backup the settings.

4.11.3 Upgrade Manager

The Upgrade Manager page allows you to configure a remote TFTP sever or host file system in order to upload firmware upgrade images or configuration files.

To access this page, click **Tools > Upgrade Manager**.

Figure 4.220 Tools > Upgrade Manager

The following table describes the items in the previous figure.

Item	Description
Upgrade Method	Click the drop-down menu to select the upgrade method: TFTP or HTTP.
Server IP	Enter the IP address of the upgrade server.
File Name	Enter the file name of the new firmware version.
Upgrade Type	Click a type to define the upgrade method: image, startup configuration, running configuration, or custom configuration.
Image	Click the format for the image type: Active, Backup, or auto.
Upgrade	Click Upgrade to upgrade to the current version.

4.11.4 Dual Image

The Dual Image page allows you to setup an active and backup partitions for firmware image redundancy.

To access this page, click **Tools > Dual Image**.

Figure 4.221 Tools > Dual Image

The following table describes the items in the previous figure.

Item	Description
Active Image	Click the format for the image type: Active or Backup.
Save	Click Save to save and keep the new settings.

The ensuing table for **Image Information 0/1** settings are informational only: Flash Partition, Image Name, Image Size and Created Time.

4.11.5 Save Configuration

To access this page, click **Tools > Save Configuration**.

Click **Save Configuration to FLASH** to have configuration changes you have made to be saved across a system reboot. All changes submitted since the previous save or system reboot will be retained by the switch.

4.11.6 User Account

4.11.6.1 Add and Edit Users

The User Account page allows you to setup a user and the related parameters.

To access this page, click **Tools > User Account**.

Figure 4.222 Tools > User Account

The following table describes the items in the previous figure.

Item	Description
User Name	Enter the name of the new user entry.
Password Type	Click the drop-down menu to define the type of password: Clear Text , Encrypted or No Password .
Password	Enter the character set for the define password type.
Retype Password	Retype the password entry to confirm the profile password.
Privilege Type	Click the drop-down menu to designate privilege authority for the user entry: Admin or User .
Apply	Click Apply to create a new user account.

4.11.6.2 Wrong Password

To access this page, click **Tools > User Account**.

The following figure displays the **Wrong Password** settings.

Figure 4.223 Tools > User Account

To access this page, click **Tools > User Account**.

Item	Description
State	Click to enable or disable the wrong password detection function.
Retry Time	Enter a variable to designate the wrong password entry threshold, State option must be enabled.
Block Time	Enter a variable to designate the lockout period in minutes after the retry attempts threshold is reached.
Apply	Click Apply to create a new user account.

The following figure displays the **Wrong Password Information** settings.

Information Name	Information Value
State	Disabled
Retry Time	5
Block Time	10 minutes

Figure 4.224 Tools > User Account

4.11.7 N-Key

To access this page, click **Tools > N-Key**.

Figure 4.225 Tools > N-Key

The following table describes the items in the previous figure.

Item	Description
Auto Mode	Click the option to set the auto mode for the N-Key status.
N-Key Status	Click the drop-down menu to select N-Key status.
Apply	Click Apply to create a new user account.

To access this page, click **Tools > N-Key**.

The following figure displays the **N-Key Information** settings.

Information Name	Information Value
Auto Mode	Enabled
N-Key Status	N-key is idle

Figure 4.226 Tools > N-Key Information

4.11.8 Reset System

To access this page, click **Tools > Reset System**.

Click **Restore** to have all configuration parameters reset to their factory default values. All changes that have been made will be lost, even if you have issued a save.

Click **Select Excepted Configuration** to keep the configuration you selected when resetting.

Reset settings take effect after a system reboot.

4.11.9 Reboot Device

To access this page, click **Tools > Reboot Device**.

Click **Reboot** to reboot the switch. Any configuration changes you have made since the last time you issued a save will be lost.

4.12 Modbus/TCP Mapping

The data map addresses of Advantech switches shown in the following table start from Modbus address 30001 for function code 4.

In the given example, the address offset 0x1000 (hex) equals Modbus address 34097, while the address offset 0x1100 (hex) equals Modbus address 34353.

The information given by the Advantech is shown in hex mode.

4.12.1 Modbus/TCP Mapping Table

Catalog	Name	Data Type	Interpretation	Address Offset (Hex)	Address 3X	Description	
System Info	Vendor ID = 0x'13FE	1 word	16 bits	HEX	0x0000	30001	Vendor ID = 0x13FE
	Unit ID = 0xFF	1 word	16 bits	HEX	0x0001	30002	Unit ID = 0xFF
	Product Code	1 word	16 bits	HEX	0x0002	30003	Product Code
	Vendor Name = "Advantech"	16 words	32 chars	ASCII	0x0010	30017	Vendor Name = "Advantech" Word 0 Hi byte = 'A' Word 0 Lo byte = 'd' Word 1 Hi byte = 'v' Word 1 Lo byte = 'a' Word 2 Hi byte = 'n' Word 2 Lo byte = 't' Word 3 Hi byte = 'e' Word 3 Lo byte = 'c' Word 4 Hi byte = 'h' Word 4 Lo byte = '\0'
	Product Name = "EKI-xxxx"	16 words	32 chars	ASCII	0x0020	30033	Product Name = "EKI-xxxx" Word 0 Hi byte = 'E' Word 0 Lo byte = 'K' Word 1 Hi byte = 'I' Word 1 Lo byte = '-' Word 2 Hi byte = 'x' Word 2 Lo byte = 'x' Word 3 Hi byte = 'x' Word 3 Lo byte = 'x' Word 4 Hi byte = '\0'
Firmware Version	2 words	32 bits	HEX	0x020A	30523	Firmware Version Word 0 Hi byte = major Word 0 Lo byte = minor Word 1 Hi byte = release Word 1 Lo byte = build	
Ethernet MAC Address	3 words	48 bits	HEX	0x020E	30527	Ethernet MAC Address Ex: MAC = 00-19-CB-01-02-03 Word 0 Hi byte = 0x00 Word 0 Lo byte = 0x19 Word 1 Hi byte = 0xCB Word 1 Lo byte = 0x01 Word 2 Hi byte = 0x02 Word 2 Lo byte = 0x03	

Catalog	Name	Data Type	Interpretation	Address Offset (Hex)	Address 3X	Description	
System Info	Revision Number	16 words	32 chars	ASCII	0x0211	30530	Product Name = "YYY.xxxx" Word 0 Hi byte = 'Y' Word 0 Lo byte = 'Y' Word 1 Hi byte = 'Y' Word 1 Lo byte = '.' Word 2 Hi byte = 'x' Word 2 Lo byte = 'x' Word 3 Hi byte = 'x' Word 3 Lo byte = 'x' Word 4 Hi byte = 'x' Word 4 Lo byte = '\0'
	IP Address	2 words	32 bits	HEX	0x0400	31025	IP Address Ex: IP = 192.168.1.1 Word 0 Hi byte = 0xC0 Word 0 Lo byte = 0xA8 Word 1 Hi byte = 0x01 Word 1 Lo byte = 0x01
Port Info	Port Status	1 word	16 bits	HEX	0x1000 ~ 0x101F	34097 ~ 34128	Port Status 0x0000: Link down 0x0001: Link up 0xFFFF: No port
	Port 1 Status	1 word	16 bits	HEX	0x1000	34097	
	Port 2 Status	1 word	16 bits	HEX	0x1001	34098	
	Port 3 Status	1 word	16 bits	HEX	0x1002	34099	
	Port 4 Status	1 word	16 bits	HEX	0x1003	34100	
	Port 5 Status	1 word	16 bits	HEX	0x1004	34101	
	Port 6 Status	1 word	16 bits	HEX	0x1005	34102	
	Port 7 Status	1 word	16 bits	HEX	0x1006	34103	
	Port 8 Status	1 word	16 bits	HEX	0x1007	34104	
	Port 9 Status	1 word	16 bits	HEX	0x1008	34105	
	Port 10 Status	1 word	16 bits	HEX	0x1009	34106	
	Port 11 Status	1 word	16 bits	HEX	0x100A	34107	
	Port 12 Status	1 word	16 bits	HEX	0x100B	34108	
	Port 13 Status	1 word	16 bits	HEX	0x100C	34109	
	Port 14 Status	1 word	16 bits	HEX	0x100D	34110	
	Port 15 Status	1 word	16 bits	HEX	0x100E	34111	
	Port 16 Status	1 word	16 bits	HEX	0x100F	34112	
	Port 17 Status	1 word	16 bits	HEX	0x1010	34113	
	Port 18 Status	1 word	16 bits	HEX	0x1011	34114	
	Port 19 Status	1 word	16 bits	HEX	0x1012	34115	
	Port 20 Status	1 word	16 bits	HEX	0x1013	34116	
	Port 21 Status	1 word	16 bits	HEX	0x1014	34117	
	Port 22 Status	1 word	16 bits	HEX	0x1015	34118	
	Port 23 Status	1 word	16 bits	HEX	0x1016	34119	
	Port 24 Status	1 word	16 bits	HEX	0x1017	34120	
	Port 25 Status	1 word	16 bits	HEX	0x1018	34121	
	Port 26 Status	1 word	16 bits	HEX	0x1019	34122	
	Port 27 Status	1 word	16 bits	HEX	0x101A	34123	
	Port 28 Status	1 word	16 bits	HEX	0x101B	34124	
	Port 29 Status	1 word	16 bits	HEX	0x101C	34125	
	Port 30 Status	1 word	16 bits	HEX	0x101D	34126	
	Port 31 Status	1 word	16 bits	HEX	0x101E	34127	
	Port 32 Status	1 word	16 bits	HEX	0x101F	34128	

Catalog	Name	Data Type	Interpretation	Address Offset (Hex)	Address 3X	Description
Port Info	Port Speed	1 word 16 bits	HEX	0x1100 ~ 0x111F	34353 ~ 34384	Port Speed 0x0000: 10M-Half 0x0001: 10M-Full 0x0002: 100M-Half 0x0003: 100M-Full 0x0004: 1000M-Half 0x0005: 1000M-Full 0xFFFF: No port
	Port 1 Speed	1 word 16 bits	HEX	0x1100	34353	
	Port 2 Speed	1 word 16 bits	HEX	0x1101	34354	
	Port 3 Speed	1 word 16 bits	HEX	0x1102	34355	
	Port 4 Speed	1 word 16 bits	HEX	0x1103	34356	
	Port 5 Speed	1 word 16 bits	HEX	0x1104	34357	
	Port 6 Speed	1 word 16 bits	HEX	0x1105	34358	
	Port 7 Speed	1 word 16 bits	HEX	0x1106	34359	
	Port 8 Speed	1 word 16 bits	HEX	0x1107	34360	
	Port 9 Speed	1 word 16 bits	HEX	0x1108	34361	
	Port 10 Speed	1 word 16 bits	HEX	0x1109	34362	
	Port 11 Speed	1 word 16 bits	HEX	0x110A	34363	
	Port 12 Speed	1 word 16 bits	HEX	0x110B	34364	
	Port 13 Speed	1 word 16 bits	HEX	0x110C	34365	
	Port 14 Speed	1 word 16 bits	HEX	0x110D	34366	
	Port 15 Speed	1 word 16 bits	HEX	0x110E	34367	
	Port 16 Speed	1 word 16 bits	HEX	0x110F	34368	
	Port 17 Speed	1 word 16 bits	HEX	0x1110	34369	
	Port 18 Speed	1 word 16 bits	HEX	0x1111	34370	
	Port 19 Speed	1 word 16 bits	HEX	0x1112	34371	
	Port 20 Speed	1 word 16 bits	HEX	0x1113	34372	
	Port 21 Speed	1 word 16 bits	HEX	0x1114	34373	
	Port 22 Speed	1 word 16 bits	HEX	0x1115	34374	
	Port 23 Speed	1 word 16 bits	HEX	0x1116	34375	
	Port 24 Speed	1 word 16 bits	HEX	0x1117	34376	
	Port 25 Speed	1 word 16 bits	HEX	0x1118	34377	
	Port 26 Speed	1 word 16 bits	HEX	0x1119	34378	
	Port 27 Speed	1 word 16 bits	HEX	0x111A	34379	
	Port 28 Speed	1 word 16 bits	HEX	0x111B	34380	
	Port 29 Speed	1 word 16 bits	HEX	0x111C	34381	
	Port 30 Speed	1 word 16 bits	HEX	0x111D	34382	
	Port 31 Speed	1 word 16 bits	HEX	0x111E	34383	
	Port 32 Speed	1 word 16 bits	HEX	0x111F	34384	
	Flow Control	1 word 16 bits	HEX	0x1200 ~ 0x121F	34609 ~ 34640	Flow Control 0x0000: Off 0x0001: On 0xFFFF: No port
	Port 1 Flow Control	1 word 16 bits	HEX	0x1200	34609	
	Port 2 Flow Control	1 word 16 bits	HEX	0x1201	34610	
	Port 3 Flow Control	1 word 16 bits	HEX	0x1202	34611	
	Port 4 Flow Control	1 word 16 bits	HEX	0x1203	34612	
	Port 5 Flow Control	1 word 16 bits	HEX	0x1204	34613	
	Port 6 Flow Control	1 word 16 bits	HEX	0x1205	34614	

Catalog	Name	Data Type	Interpretation	Address Offset (Hex)	Address 3X	Description
Port Info	Port 7 Flow Control	1 word	16 bits	HEX	0x1206	34615
	Port 8 Flow Control	1 word	16 bits	HEX	0x1207	34616
	Port 9 Flow Control	1 word	16 bits	HEX	0x1208	34617
	Port 10 Flow Control	1 word	16 bits	HEX	0x1209	34618
	Port 11 Flow Control	1 word	16 bits	HEX	0x120A	34619
	Port 12 Flow Control	1 word	16 bits	HEX	0x120B	34620
	Port 13 Flow Control	1 word	16 bits	HEX	0x120C	34621
	Port 14 Flow Control	1 word	16 bits	HEX	0x120D	34622
	Port 15 Flow Control	1 word	16 bits	HEX	0x120E	34623
	Port 16 Flow Control	1 word	16 bits	HEX	0x120F	34624
	Port 17 Flow Control	1 word	16 bits	HEX	0x1210	34625
	Port 18 Flow Control	1 word	16 bits	HEX	0x1211	34626
	Port 19 Flow Control	1 word	16 bits	HEX	0x1212	34627
	Port 20 Flow Control	1 word	16 bits	HEX	0x1213	34628
	Port 21 Flow Control	1 word	16 bits	HEX	0x1214	34629
	Port 22 Flow Control	1 word	16 bits	HEX	0x1215	34630
	Port 23 Flow Control	1 word	16 bits	HEX	0x1216	34631
	Port 24 Flow Control	1 word	16 bits	HEX	0x1217	34632
	Port 25 Flow Control	1 word	16 bits	HEX	0x1218	34633
	Port 26 Flow Control	1 word	16 bits	HEX	0x1219	34634
	Port 27 Flow Control	1 word	16 bits	HEX	0x121A	34635
	Port 28 Flow Control	1 word	16 bits	HEX	0x121B	34636
	Port 29 Flow Control	1 word	16 bits	HEX	0x121C	34637
	Port 30 Flow Control	1 word	16 bits	HEX	0x121D	34638
	Port 31 Flow Control	1 word	16 bits	HEX	0x121E	34639
	Port 32 Flow Control	1 word	16 bits	HEX	0x121F	34640

Catalog	Name	Data Type	Interpretation	Address Offset (Hex)	Address 3X	Description	
Port Info	Port Description	20 words	40 chars	ASCII	0x1400 ~ 0x166C	35121 ~ 35741	Port Description Port Description = "100RX,RJ45." Word 0 Hi byte = '1' Word 0 Lo byte = '0' Word 1Hi byte = '0' Word 1 Lo byte = 'R' Word 2 Hi byte = 'X' Word 2 Lo byte = ',' Word 3 Hi byte = 'R' Word 3 Lo byte = 'J' Word 4 Hi byte = '4' Word 4 Lo byte = '5' Word 5 Hi byte = '.' Word 5 Lo byte = '\0'
	Port 1 Description	20 words	40 chars	ASCII	0x1400	35121	
	Port 2 Description	20 words	40 chars	ASCII	0x1414	35141	
	Port 3 Description	20 words	40 chars	ASCII	0x1428	35161	
	Port 4 Description	20 words	40 chars	ASCII	0x143C	35181	
	Port 5 Description	20 words	40 chars	ASCII	0x1450	35201	
	Port 6 Description	20 words	40 chars	ASCII	0x1464	35221	
	Port 7 Description	20 words	40 chars	ASCII	0x1478	35241	
	Port 8 Description	20 words	40 chars	ASCII	0x148C	35261	
	Port 9 Description	20 words	40 chars	ASCII	0x14A0	35281	
	Port 10 Description	20 words	40 chars	ASCII	0x14B4	35301	
	Port 11 Description	20 words	40 chars	ASCII	0x14C8	35321	
	Port 12 Description	20 words	40 chars	ASCII	0x14DC	35341	
	Port 13 Description	20 words	40 chars	ASCII	0x14F0	35361	
	Port 14 Description	20 words	40 chars	ASCII	0x1504	35381	
	Port 15 Description	20 words	40 chars	ASCII	0x1518	35401	
	Port 16 Description	20 words	40 chars	ASCII	0x152C	35421	
	Port 17 Description	20 words	40 chars	ASCII	0x1540	35441	
	Port 18 Description	20 words	40 chars	ASCII	0x1554	35461	
	Port 19 Description	20 words	40 chars	ASCII	0x1568	35481	
	Port 20 Description	20 words	40 chars	ASCII	0x157C	35501	
	Port 21 Description	20 words	40 chars	ASCII	0x1590	35521	
	Port 22 Description	20 words	40 chars	ASCII	0x15A4	35541	
	Port 23 Description	20 words	40 chars	ASCII	0x15B8	35561	

Catalog	Name	Data Type		Interpretation	Address Offset (Hex)	Address 3X	Description
Port Info	Port 24 Description	20 words	40 chars	ASCII	0x15CC	35581	
	Port 25 Description	20 words	40 chars	ASCII	0x15E0	35601	
	Port 26 Description	20 words	40 chars	ASCII	0x15F4	35621	
	Port 27 Description	20 words	40 chars	ASCII	0x1608	35641	
	Port 28 Description	20 words	40 chars	ASCII	0x161C	35661	
	Port 29 Description	20 words	40 chars	ASCII	0x1630	35681	
	Port 30 Description	20 words	40 chars	ASCII	0x1644	35701	
	Port 31 Description	20 words	40 chars	ASCII	0x1658	35721	
	Port 32 Description	20 words	40 chars	ASCII	0x166C	35741	
	Link Up Counter	1 word	16 bits	HEX	0x1700 ~ 0x171F	35889 ~ 35920	Link Up Counter Ex: port link up counter = 13 Received MODBUS response: 0x000D
	Port 1 Link Up Counter	1 word	16 bits	HEX	0x1700	35889	
	Port 2 Link Up Counter	1 word	16 bits	HEX	0x1701	35890	
	Port 3 Link Up Counter	1 word	16 bits	HEX	0x1702	35891	
	Port 4 Link Up Counter	1 word	16 bits	HEX	0x1703	35892	
	Port 5 Link Up Counter	1 word	16 bits	HEX	0x1704	35893	
	Port 6 Link Up Counter	1 word	16 bits	HEX	0x1705	35894	
	Port 7 Link Up Counter	1 word	16 bits	HEX	0x1706	35895	
	Port 8 Link Up Counter	1 word	16 bits	HEX	0x1707	35896	
	Port 9 Link Up Counter	1 word	16 bits	HEX	0x1708	35897	
	Port 10 Link Up Counter	1 word	16 bits	HEX	0x1709	35898	
	Port 11 Link Up Counter	1 word	16 bits	HEX	0x170A	35899	
	Port 12 Link Up Counter	1 word	16 bits	HEX	0x170B	35900	
	Port 13 Link Up Counter	1 word	16 bits	HEX	0x170C	35901	
Port 14 Link Up Counter	1 word	16 bits	HEX	0x170D	35902		
Port 15 Link Up Counter	1 word	16 bits	HEX	0x170E	35903		
Port 16 Link Up Counter	1 word	16 bits	HEX	0x170F	35904		
Port 17 Link Up Counter	1 word	16 bits	HEX	0x1710	35905		
Port 18 Link Up Counter	1 word	16 bits	HEX	0x1711	35906		
Port 19 Link Up Counter	1 word	16 bits	HEX	0x1712	35907		

Catalog	Name	Data Type	Interpretation	Address Offset (Hex)	Address 3X	Description	
Port Info	Port 20 Link Up Counter	1 word	16 bits	HEX	0x1713	35908	
	Port 21 Link Up Counter	1 word	16 bits	HEX	0x1714	35909	
	Port 22 Link Up Counter	1 word	16 bits	HEX	0x1715	35910	
	Port 23 Link Up Counter	1 word	16 bits	HEX	0x1716	35911	
	Port 24 Link Up Counter	1 word	16 bits	HEX	0x1717	35912	
	Port 25 Link Up Counter	1 word	16 bits	HEX	0x1718	35913	
	Port 26 Link Up Counter	1 word	16 bits	HEX	0x1719	35914	
	Port 27 Link Up Counter	1 word	16 bits	HEX	0x171A	35915	
	Port 28 Link Up Counter	1 word	16 bits	HEX	0x171B	35916	
	Port 29 Link Up Counter	1 word	16 bits	HEX	0x171C	35917	
	Port 30 Link Up Counter	1 word	16 bits	HEX	0x171D	35918	
	Port 31 Link Up Counter	1 word	16 bits	HEX	0x171E	35919	
	Port 32 Link Up Counter	1 word	16 bits	HEX	0x171F	35920	
	Packet Info	Tx Packets Counter	4 words	64 bits	HEX	0x2000 ~ 0x207C	38193 ~ 38317
Port 1 Tx Packets		4 words	64 bits	HEX	0x2000	38193	
Port 2 Tx Packets		4 words	64 bits	HEX	0x2004	38197	
Port 3 Tx Packets		4 words	64 bits	HEX	0x2008	38201	
Port 4 Tx Packets		4 words	64 bits	HEX	0x200C	38205	
Port 5 Tx Packets		4 words	64 bits	HEX	0x2010	38209	
Port 6 Tx Packets		4 words	64 bits	HEX	0x2014	38213	
Port 7 Tx Packets		4 words	64 bits	HEX	0x2018	38217	
Port 8 Tx Packets		4 words	64 bits	HEX	0x201C	38221	
Port 9 Tx Packets		4 words	64 bits	HEX	0x2020	38225	
Port 10 Tx Packets		4 words	64 bits	HEX	0x2024	38229	
Port 11 Tx Packets		4 words	64 bits	HEX	0x2028	38233	
Port 12 Tx Packets		4 words	64 bits	HEX	0x202C	38237	
Port 13 Tx Packets		4 words	64 bits	HEX	0x2030	38241	

Catalog	Name	Data Type	Interpretation	Address Offset (Hex)	Address 3X	Description	
Packet Info	Port 14 Tx Packets	4 words	64 bits	HEX	0x2034	38245	
	Port 15 Tx Packets	4 words	64 bits	HEX	0x2038	38249	
	Port 16 Tx Packets	4 words	64 bits	HEX	0x203C	38253	
	Port 17 Tx Packets	4 words	64 bits	HEX	0x2040	38257	
	Port 18 Tx Packets	4 words	64 bits	HEX	0x2044	38261	
	Port 19 Tx Packets	4 words	64 bits	HEX	0x2048	38265	
	Port 20 Tx Packets	4 words	64 bits	HEX	0x204C	38269	
	Port 21 Tx Packets	4 words	64 bits	HEX	0x2050	38273	
	Port 22 Tx Packets	4 words	64 bits	HEX	0x2054	38277	
	Port 23 Tx Packets	4 words	64 bits	HEX	0x2058	38281	
	Port 24 Tx Packets	4 words	64 bits	HEX	0x205C	38285	
	Port 25 Tx Packets	4 words	64 bits	HEX	0x2060	38289	
	Port 26 Tx Packets	4 words	64 bits	HEX	0x2064	38293	
	Port 27 Tx Packets	4 words	64 bits	HEX	0x2068	38297	
	Port 28 Tx Packets	4 words	64 bits	HEX	0x206C	38301	
	Port 29 Tx Packets	4 words	64 bits	HEX	0x2070	38305	
	Port 30 Tx Packets	4 words	64 bits	HEX	0x2074	38309	
	Port 31 Tx Packets	4 words	64 bits	HEX	0x2078	38313	
	Port 32 Tx Packets	4 words	64 bits	HEX	0x207C	38317	
	Rx Packets Counter	4 words	64 bits	HEX	0x2100 ~0x217C	38449 ~ 38573	Rx Packets Ex: port 1 Rx Packet Amount = 11223344 Received MODBUS response: 0xAB4130 Word 0 = 0x0000 Word 1 = 0x0000 Word 2 = 0x00AB Word 3 = 0x4130
	Port 1 Rx Packets	4 words	64 bits	HEX	0x2100	38449	
	Port 2 Rx Packets	4 words	64 bits	HEX	0x2104	38453	
	Port 3 Rx Packets	4 words	64 bits	HEX	0x2108	38457	
	Port 4 Rx Packets	4 words	64 bits	HEX	0x210C	38461	
	Port 5 Rx Packets	4 words	64 bits	HEX	0x2110	38465	
	Port 6 Rx Packets	4 words	64 bits	HEX	0x2114	38469	
	Port 7 Rx Packets	4 words	64 bits	HEX	0x2118	38473	

Catalog	Name	Data Type	Interpretation	Address Offset (Hex)	Address 3X	Description	
Packet Info	Port 8 Rx Packets	4 words	64 bits	HEX	0x211C	38477	
	Port 9 Rx Packets	4 words	64 bits	HEX	0x2120	38481	
	Port 10 Rx Packets	4 words	64 bits	HEX	0x2124	38485	
	Port 11 Rx Packets	4 words	64 bits	HEX	0x2128	38489	
	Port 12 Rx Packets	4 words	64 bits	HEX	0x212C	38493	
	Port 13 Rx Packets	4 words	64 bits	HEX	0x2130	38497	
	Port 14 Rx Packets	4 words	64 bits	HEX	0x2134	38501	
	Port 15 Rx Packets	4 words	64 bits	HEX	0x2138	38505	
	Port 16 Rx Packets	4 words	64 bits	HEX	0x213C	38509	
	Port 17 Rx Packets	4 words	64 bits	HEX	0x2140	38513	
	Port 18 Rx Packets	4 words	64 bits	HEX	0x2144	38517	
	Port 19 Rx Packets	4 words	64 bits	HEX	0x2148	38521	
	Port 20 Rx Packets	4 words	64 bits	HEX	0x214C	38525	
	Port 21 Rx Packets	4 words	64 bits	HEX	0x2150	38529	
	Port 22 Rx Packets	4 words	64 bits	HEX	0x2154	38533	
	Port 23 Rx Packets	4 words	64 bits	HEX	0x2158	38537	
	Port 24 Rx Packets	4 words	64 bits	HEX	0x215C	38541	
	Port 25 Rx Packets	4 words	64 bits	HEX	0x2160	38545	
	Port 26 Rx Packets	4 words	64 bits	HEX	0x2164	38549	
	Port 27 Rx Packets	4 words	64 bits	HEX	0x2168	38553	
	Port 28 Rx Packets	4 words	64 bits	HEX	0x216C	38557	
	Port 29 Rx Packets	4 words	64 bits	HEX	0x2170	38561	
	Port 30 Rx Packets	4 words	64 bits	HEX	0x2174	38565	
	Port 31 Rx Packets	4 words	64 bits	HEX	0x2178	38569	
	Port 32 Rx Packets	4 words	64 bits	HEX	0x217C	38573	
	Tx Error Packets Counter	2 words	32 bits	HEX	0x2200 ~ 0x223E	38705 ~ 38767	Tx Error Packets Ex: port 1 Tx Packet Amount = 11223344 Received MODBUS response: 0xAB4130 Word 0 = 0x00AB Word 1 = 0x4130
	Port 1 Tx Error Packets	2 words	32 bits	HEX	0x2200	38705	
	Port 2 Tx Error Packets	2 words	32 bits	HEX	0x2202	38707	

Catalog	Name	Data Type	Interpretation	Address Offset (Hex)	Address 3X	Description
Packet Info	Port 3 Tx Error Packets	2 words	32 bits	HEX	0x2204	38709
	Port 4 Tx Error Packets	2 words	32 bits	HEX	0x2206	38711
	Port 5 Tx Error Packets	2 words	32 bits	HEX	0x2208	38713
	Port 6 Tx Error Packets	2 words	32 bits	HEX	0x220A	38715
	Port 7 Tx Error Packets	2 words	32 bits	HEX	0x220C	38717
	Port 8 Tx Error Packets	2 words	32 bits	HEX	0x220E	38719
	Port 9 Tx Error Packets	2 words	32 bits	HEX	0x2210	38721
	Port 10 Tx Error Packets	2 words	32 bits	HEX	0x2212	38723
	Port 11 Tx Error Packets	2 words	32 bits	HEX	0x2214	38725
	Port 12 Tx Error Packets	2 words	32 bits	HEX	0x2216	38727
	Port 13 Tx Error Packets	2 words	32 bits	HEX	0x2218	38729
	Port 14 Tx Error Packets	2 words	32 bits	HEX	0x221A	38731
	Port 15 Tx Error Packets	2 words	32 bits	HEX	0x221C	38733
	Port 16 Tx Error Packets	2 words	32 bits	HEX	0x221E	38735
	Port 17 Tx Error Packets	2 words	32 bits	HEX	0x2220	38737
	Port 18 Tx Error Packets	2 words	32 bits	HEX	0x2222	38739
	Port 19 Tx Error Packets	2 words	32 bits	HEX	0x2224	38741
	Port 20 Tx Error Packets	2 words	32 bits	HEX	0x2226	38743
	Port 21 Tx Error Packets	2 words	32 bits	HEX	0x2228	38745
	Port 22 Tx Error Packets	2 words	32 bits	HEX	0x222A	38747
	Port 23 Tx Error Packets	2 words	32 bits	HEX	0x222C	38749
	Port 24 Tx Error Packets	2 words	32 bits	HEX	0x222E	38751
	Port 25 Tx Error Packets	2 words	32 bits	HEX	0x2230	38753
	Port 26 Tx Error Packets	2 words	32 bits	HEX	0x2232	38755
	Port 27 Tx Error Packets	2 words	32 bits	HEX	0x2234	38757
	Port 28 Tx Error Packets	2 words	32 bits	HEX	0x2236	38759
	Port 29 Tx Error Packets	2 words	32 bits	HEX	0x2238	38761
	Port 30 Tx Error Packets	2 words	32 bits	HEX	0x223A	38763
	Port 31 Tx Error Packets	2 words	32 bits	HEX	0x223C	38765
	Port 32 Tx Error Packets	2 words	32 bits	HEX	0x223E	38767

Catalog	Name	Data Type	Interpretation	Address Offset (Hex)	Address 3X	Description	
Packet Info	Rx Error Packets Counter	2 words	32 bits	HEX	0x2300 ~ 0x233E	38961 ~ 39023	Rx Error Packets Ex: port 1 Rx Packet Amount = 11223344 Received MODBUS response: 0xAB4130 Word 0 = 0x00AB Word 1 = 0x4130
	Port 1 Rx Error Packets	2 words	32 bits	HEX	0x2300	38961	
	Port 2 Rx Error Packets	2 words	32 bits	HEX	0x2302	38963	
	Port 3 Rx Error Packets	2 words	32 bits	HEX	0x2304	38965	
	Port 4 Rx Error Packets	2 words	32 bits	HEX	0x2306	38967	
	Port 5 Rx Error Packets	2 words	32 bits	HEX	0x2308	38969	
	Port 6 Rx Error Packets	2 words	32 bits	HEX	0x230A	38971	
	Port 7 Rx Error Packets	2 words	32 bits	HEX	0x230C	38973	
	Port 8 Rx Error Packets	2 words	32 bits	HEX	0x230E	38975	
	Port 9 Rx Error Packets	2 words	32 bits	HEX	0x2310	38977	
	Port 10 Rx Error Packets	2 words	32 bits	HEX	0x2312	38979	
	Port 11 Rx Error Packets	2 words	32 bits	HEX	0x2314	38981	
	Port 12 Rx Error Packets	2 words	32 bits	HEX	0x2316	38983	
	Port 13 Rx Error Packets	2 words	32 bits	HEX	0x2318	38985	
	Port 14 Rx Error Packets	2 words	32 bits	HEX	0x231A	38987	
	Port 15 Rx Error Packets	2 words	32 bits	HEX	0x231C	38989	
	Port 16 Rx Error Packets	2 words	32 bits	HEX	0x231E	38991	
	Port 17 Rx Error Packets	2 words	32 bits	HEX	0x2320	38993	
	Port 18 Rx Error Packets	2 words	32 bits	HEX	0x2322	38995	
	Port 19 Rx Error Packets	2 words	32 bits	HEX	0x2324	38997	
	Port 20 Rx Error Packets	2 words	32 bits	HEX	0x2326	38999	
	Port 21 Rx Error Packets	2 words	32 bits	HEX	0x2328	39001	
	Port 22 Rx Error Packets	2 words	32 bits	HEX	0x232A	39003	
	Port 23 Rx Error Packets	2 words	32 bits	HEX	0x232C	39005	
	Port 24 Rx Error Packets	2 words	32 bits	HEX	0x232E	39007	
	Port 25 Rx Error Packets	2 words	32 bits	HEX	0x2330	39009	
	Port 26 Rx Error Packets	2 words	32 bits	HEX	0x2332	39011	
	Port 27 Rx Error Packets	2 words	32 bits	HEX	0x2334	39013	

Catalog	Name	Data Type	Interpretation	Address Offset (Hex)	Address 3X	Description
Packet Info	Port 28 Rx Error Packets	2 words	32 bits	HEX	0x2336	39015
	Port 29 Rx Error Packets	2 words	32 bits	HEX	0x2338	39017
	Port 30 Rx Error Packets	2 words	32 bits	HEX	0x233A	39019
	Port 31 Rx Error Packets	2 words	32 bits	HEX	0x233C	39021
	Port 32 Rx Error Packets	2 words	32 bits	HEX	0x233E	39023

Chapter 5

Troubleshooting

5.1 Troubleshooting

- Verify that is using the right power cord/adapter (DC 12-48V), please don't use the power adapter with DC output higher than 48V, or it may damage this device.
- Select the proper UTP/STP cable to construct the user network. Use unshielded twisted-pair (UTP) or shield twisted-pair (STP) cable for RJ-45 connections that depend on the connector type the switch equipped: 100R Category 3, 4 or 5 cable for 10Mbps connections, 100R Category 5 cable for 100Mbps connections, or 100R Category 5e/above cable for 1000Mbps connections. Also be sure that the length of any twisted-pair connection does not exceed 100 meters (328 feet).
R = replacement letter for Ohm symbol.
- **Diagnosing LED Indicators:** To assist in identifying problems, the switch can be easily monitored through panel indicators, which describe common problems the user may encounter and where the user can find possible solutions.
- If the power indicator does not light on when the power cord is plugged in, you may have a problem with power cord. Then check for loose power connections, power losses or surges at power outlet. If you still cannot resolve the problem, contact the local dealer for assistance.
- If the LED indicators are normal and the connected cables are correct but the packets still cannot be transmitted. Please check the user system's Ethernet devices' configuration or status.

ADVANTECH

Enabling an Intelligent Planet

www.advantech.com

Please verify specifications before quoting. This guide is intended for reference purposes only.

All product specifications are subject to change without notice.

No part of this publication may be reproduced in any form or by any means, electronic, photocopying, recording or otherwise, without prior written permission of the publisher.

All brand and product names are trademarks or registered trademarks of their respective companies.

© Advantech Co., Ltd. 2021